

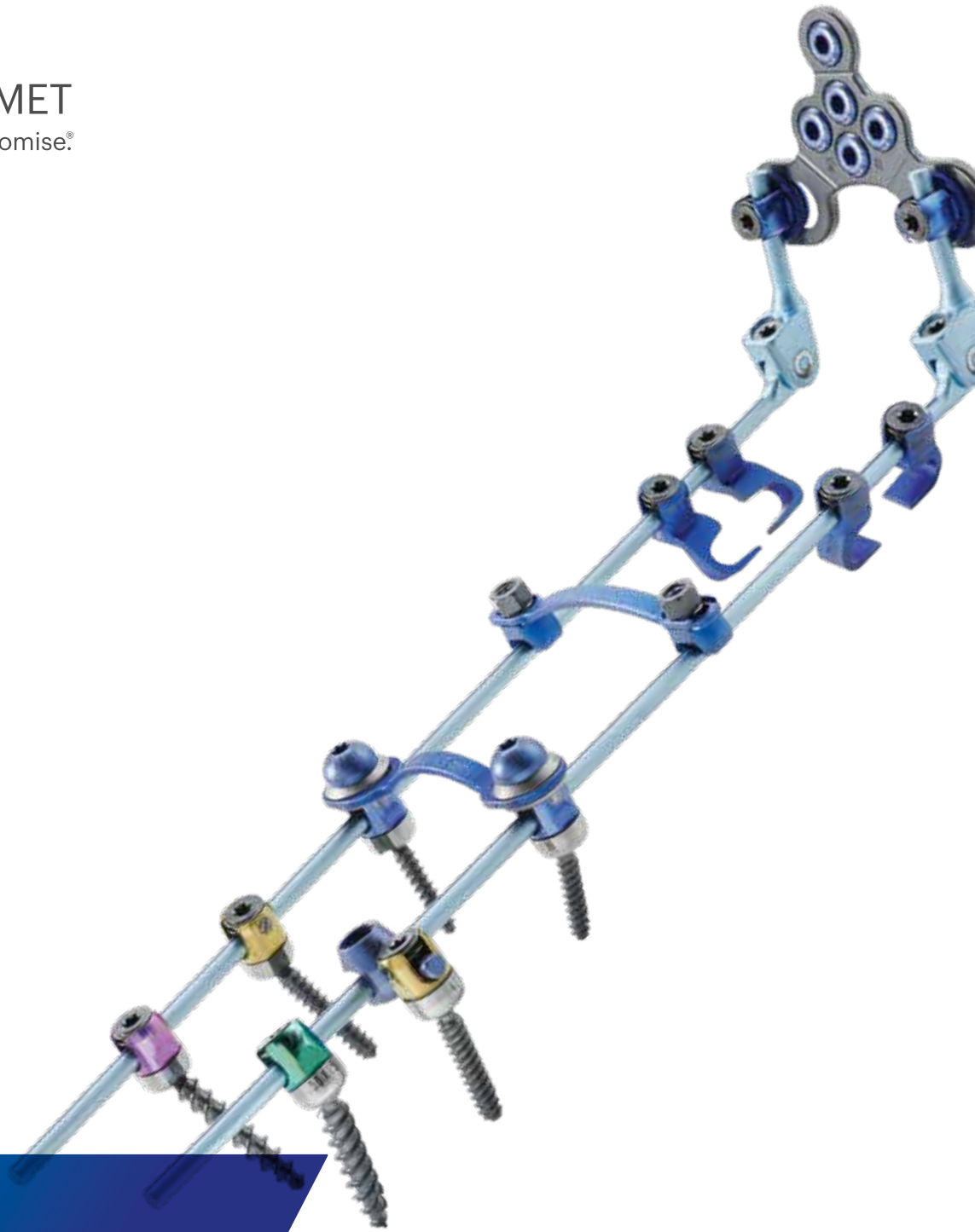

ZIMMER BIOMET

Your progress. Our promise.®



Cervical Solutions

Virage[®] OCT

Spinal Fixation System

Surgical Technique Guide

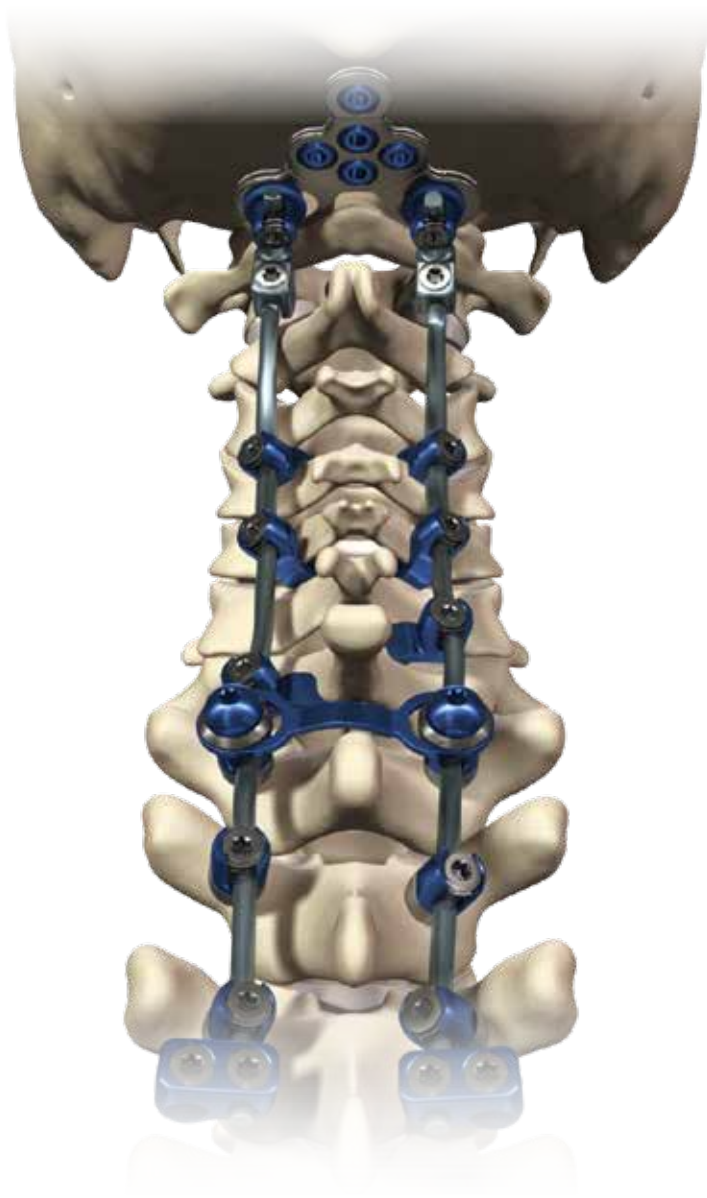

Designed to simplify rod alignment and minimize operating time while maximizing the safety and efficiency of your procedure.

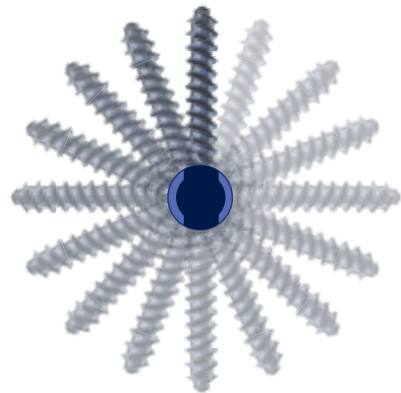

TABLE OF CONTENTS

Implant Overview	4
Patient Positioning	5
Virage OCT Spinal Fixation System	6
Virage OCT Occipitocervical	25
Virage OCT Instrument Disassembly for Cleaning	34
Virage OCT Revision and Removal	38
Kit Contents	39
Instrument Visual Guide	47
Important Information on Virage OCT Spinal Fixation System	52

Zimmer Biomet Spine does not practice medicine. This technique was developed in conjunction with health care professionals. This document is intended for surgeons and is not intended for laypersons. Each surgeon should exercise his or her own independent judgment in the diagnosis and treatment of an individual patient, and this information does not purport to replace the comprehensive training surgeons have received. As with all surgical procedures, the technique used in each case will depend on the surgeon's medical judgment as the best treatment for each patient. Results will vary based on health, weight, activity and other variables. Not all patients are candidates for this product and/or procedure.

IMPLANT OVERVIEW

Implant Overview

The Virage OCT Spinal Fixation System is designed to provide a comprehensive solution for a rigid posterior fixation of the Occipito-Cervico-Thoracic spine.

The Virage System includes multiple polyaxial screw diameters and lengths. All Virage System polyaxial screws feature a unique 360° Omnidirectional extreme angle screw design. This design seeks to simplify rod alignment and minimize operating time.

All Virage System polyaxial screws have a friction fit head designed to hold the desired position and facilitate rod placement, maximizing efficiency and safety during the procedure.

The Virage System's dual lead screws require fewer revolutions to seat in the pedicle allowing surgeons to insert screws twice as fast compared to a single lead screw.

The Virage System offers adjustable head to head transverse connectors that can accommodate up to 20° of freedom in different planes to improve intraoperative surgical flow.

The Virage System also offers a variety of implant options including rod to rod transverse connectors, ø3.5 mm/5.5 mm rod connectors, pre-cut and pre-bent ø3.5 mm Ti rods, ø3.5 mm CoCr rods, ø3.5 mm/5.5 mm transition rods, lateral offset connectors, hooks, occipital plates, occipital eyelets, and ø3.5 mm/3.8 mm pre-contoured and adjustable occipital rods.

The Virage System instrumentation allows the surgeon the flexibility to build a construct that meets anatomical challenges and handles the pathology being treated.

All implants in the Virage System (except the cobalt chrome rods) are manufactured from titanium alloy Ti 6Al-4V ELI. Rods are available in two different materials: titanium alloy and cobalt chrome.

Occipitocervical Surgical Technique Implant Overview:

The Virage System offers three adjustable occipital plate sizes to accommodate the patient's anatomy. An occipital strap is available for fixation to the superior midline fixation hole. The Virage System offers ø4.5 mm/5.25 occipital bone screws that have cortical threads.

The Virage System has many occipital rod options including: adjustable titanium, pre-contoured titanium, and pre-contoured cobalt chrome. Rods transition to a 3.8 mm diameter occipital portion to allow for a stronger construct.

The Virage System utilizes QuickFlip Guides to allow for plate retention and drill/tap guidance at 2 mm increments without changing instrumentation.

Polyaxial Screws

The Virage System polyaxial screws are available in diameters of 3.5mm, 4.0mm, 4.5mm, and 5.0mm. The lengths range from 10mm–45mm depending on diameter. Refer to the table below:

COLOR	DIAMETER	LENGTHS	INCREMENTS
Dark Blue	3.5 mm	10 mm–34 mm	Every 2 mm
Gold	4.0 mm	10 mm–34 mm	Every 2 mm
Magenta	4.5 mm	20 mm–45 mm	Every 5 mm
Green	5.0 mm	20 mm–45 mm	Every 5 mm

Smooth Shank Screws

The Virage System smooth shank polyaxial screws are available in diameters of 3.5mm and 4.0mm. The length of the smooth portion varies with different screw lengths. The caddy will have two numbers associated with each screw size, the first being the length of the smooth portion and the second being the length of threaded portion. The sum of the two numbers will be the total length of the screw.

DIAMETER	LENGTHS	INCREMENTS
3.5mm	24 mm–34 mm	Every 2 mm
4.0mm	24 mm–34 mm	Every 2 mm

Note: Lengths of 22 mm and 36 mm–40 mm can be found in the Deluxe Tray.

PATIENT POSITIONING

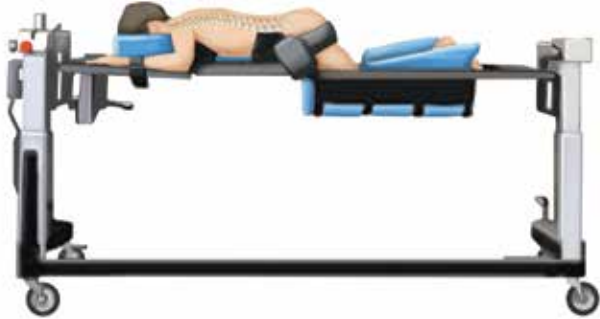

Figure 1
Patient positioning

STEP 1

- Place the patient on a radiolucent operating table in the prone position with the head and neck held securely in proper alignment. Drape the patient for posterior spinal fusion (Figure 1).

Note: The following Surgical Technique Guide describes the recommended placement and use of all Virage Cervico-Thoracic Spinal System components.

Note: When placed in the posterior cervical spine, the screws may be implanted in the following locations:

- C1 lateral mass
- C2 Pedicle and Pars Interarticularis
- C2 Translaminar
- C1–C2 Transarticular
- C3–C7 Lateral Mass, and
- C3–C7 Pedicle.

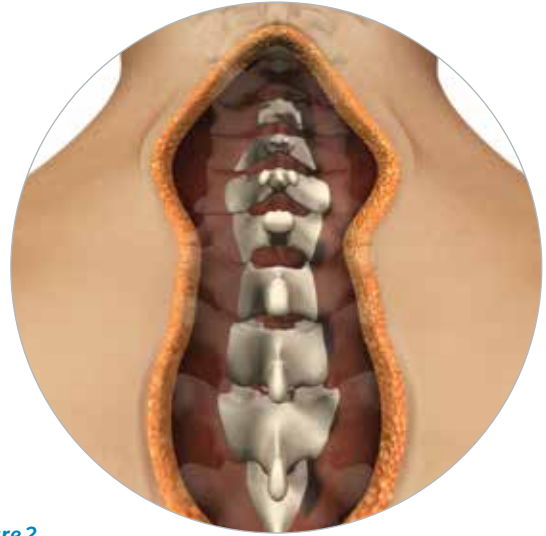

Figure 2
Exposure

STEP 2

- Complete a midline subperiosteal incision and dissection down to the spinous processes of the appropriate vertebrae. Extend dissection laterally to expose the facets and transverse processes (Figure 2).

Note: Care must be taken to avoid vital structures, including but not limited to the vertebral arteries, nerve roots, and the spinal cord.

Warning: Care should be taken during bone preparation to avoid damage to the pedicle and to the surgical instruments.

VIRAGE OCT SPINAL FIXATION SYSTEM



Figure 3
Polyaxial screw hole preparation

STEP 3

- Insert the bone awl or a burr to break the cortical surface. The bone awl has a hard stop that limits insertion to 8 mm. Repeat for all screw placement sites (**Figure 3**).

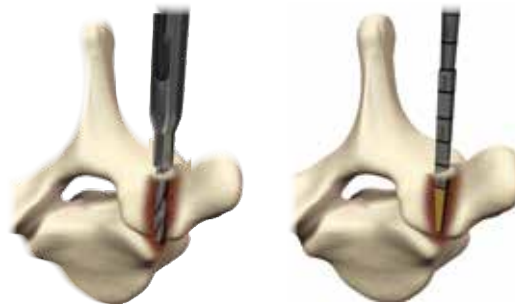

Figure 4
Drill/Probe

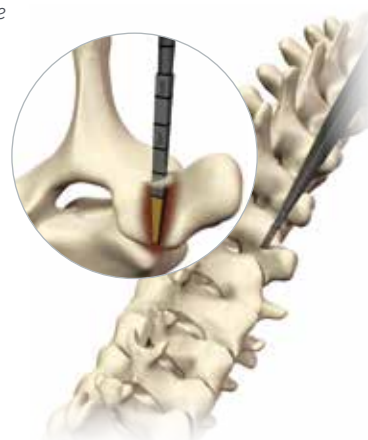

Figure 5
Option A: Probe

STEP 4

- Determine drill or probe penetration depth based on radiographic films or fluoroscopy. K-wires or pedicle markers may be placed into the pedicle throughout the preparation, confirming position on radiographs to manage orientation and trajectory. Caution should be taken to make sure the hole is not prepared too deep (**Figure 4**).

Warning: Instrument and implants may cause soft tissue damage. Care should be taken to minimize damage.

STEP 4, OPTION A

- Insert the pedicle probe in the previously prepared entry point while maintaining the appropriate trajectory. Advance the pedicle probe to the desired depth using the depth markings as a guide (**Figure 5**).

Note: Pedicle probes are gold up to 10mm.



Figure 6

Option B: Setting drill guide depth

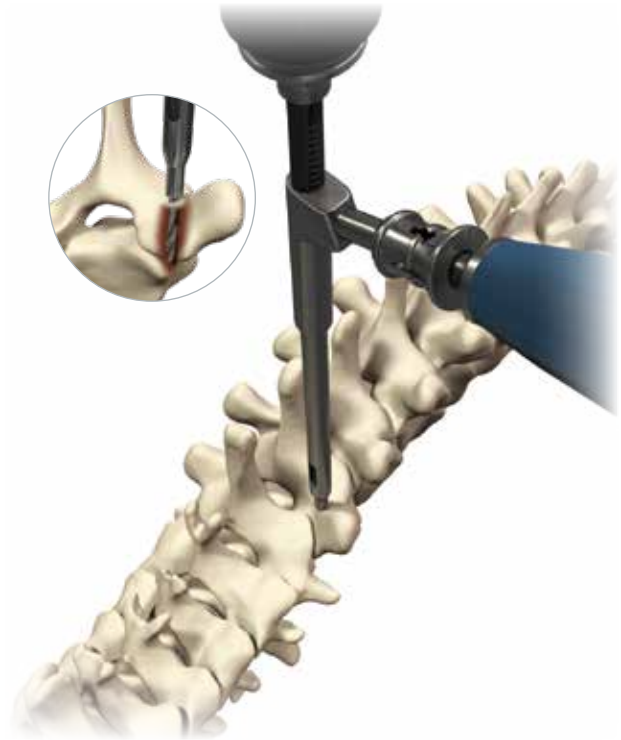

Figure 7

Option B: Drilling

STEP 4, OPTION B

- The drill guide allows for drilling depth between 8 mm–40 mm in 2 mm increments.
- Drill Guide Adjustable Setup: Hold the drill guide handle with the drill guide tip oriented vertically so the numbers are upright and readable.
- Pull back the knob toward the handle, then lift or lower the rack to the desired depth. Once the desired depth is reached, release the knob to lock the drill guide. The depth is set correctly when the silver band is lined up with the numerical marking that matches the desired length of the screw. Press on the top of the rack to be sure it is locked in place (Figure 6).
- Drill Guide Fixed Setup: The drill guide can be utilized as a fixed drill guide by placing in the “FIX” setting or the fully seated position. The depth is set correctly when the silver band is lined up with the FIX marking (Figure 6, inset).

- The Virage System offers four fixed drills:

SIZE	COLOR
10 mm	Gold
12 mm	Magenta
14 mm	Green
16 mm	Light Blue

Note: Fixed drills have a colored band that matches the tray color for that screw length.

- Attach the adjustable drill or fixed drills to the A-O handle with spin cap and insert through the drill guide.
- Orient the drill guide and drill at the desired trajectory and drill until reaching the positive stop. The positive stop is reached when the drill stop contacts the top of the drill guide (Figure 7).

Note: The A-O connection of the adjustable drill is gold.

VIRAGE OCT SPINAL FIXATION SYSTEM (continued)



Figure 8

Verify hole integrity and depth

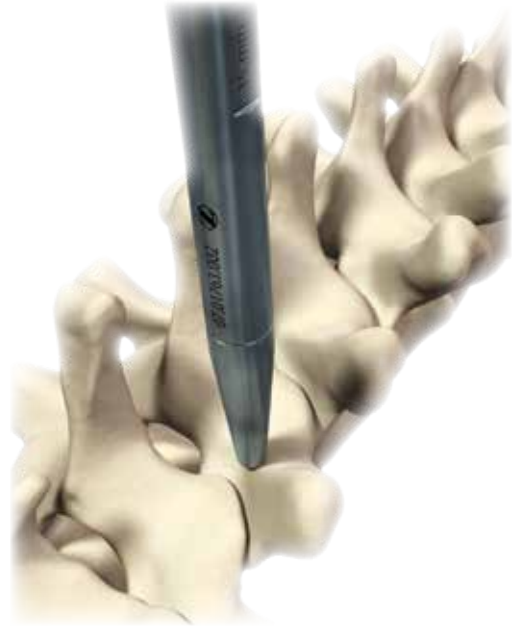

Figure 9

Tapping (optional)

STEP 5

- Confirm bone integrity and measure hole depth using the sounding probe (Figure 8).

Note: The sounding probe tip is gold up to 10 mm. There are 2 mm markings from 10 mm–20 mm, then every 5 mm from 20 mm–50 mm.

STEP 6

- Virage System polyaxial screws are self-tapping. If tapping is desired, the screw hole may be tapped using the appropriate diameter tap (Figure 9).
- The Virage System offers taps that are marked true to size:

Small Tap, ø3.5/ø4.0mm Screws

ø3.0 mm Tap

ø3.5 mm Tap

Note: Tap threads are colored gold up to 10 mm.

Large Tap, ø4.5/ø5.0mm Screws

ø4.0 mm Tap

ø4.5 mm Tap

Note: Tap threads are colored black up to 30 mm.



Figure 10
Tapping (optional)

- A tap sleeve is available if desired. Assemble tap sleeve by sliding large opening over the tap thread. Laser marked lines on proximal end of tap indicate depth of the tap (Figure 10).

Note: Tap tips are laser marked every 5 mm.

Note: The $\varnothing 3.5$ mm tap sleeve is compatible with the $\varnothing 3.0$ mm/ $\varnothing 3.5$ mm taps. The $\varnothing 4.5$ mm tap sleeve is compatible with the $\varnothing 4.0$ mm/ $\varnothing 4.5$ mm taps.



Figure 11
Polyaxial screw driver assembly

STEP 7

- Assemble the three piece screw driver by sliding the blue outer sleeve over the inner sleeve until fully engaged on the retaining feature (Figure 11, top).
- Next, depress button on inner sleeve knob and slide the hex screw driver through the inner sleeve. Slide until fully seated. Release button and confirm retention (Figure 11, bottom).
- Connect the screw driver to the A-O handle.

VIRAGE OCT SPINAL FIXATION SYSTEM (*continued*)



Figure 12
Polyaxial screw loading

STEP 8

- Insert the hex of the screw driver into the screw shank (Figure 12, top).
- Secure the screw by rotating the knob clockwise until tight (Figure 12, bottom).

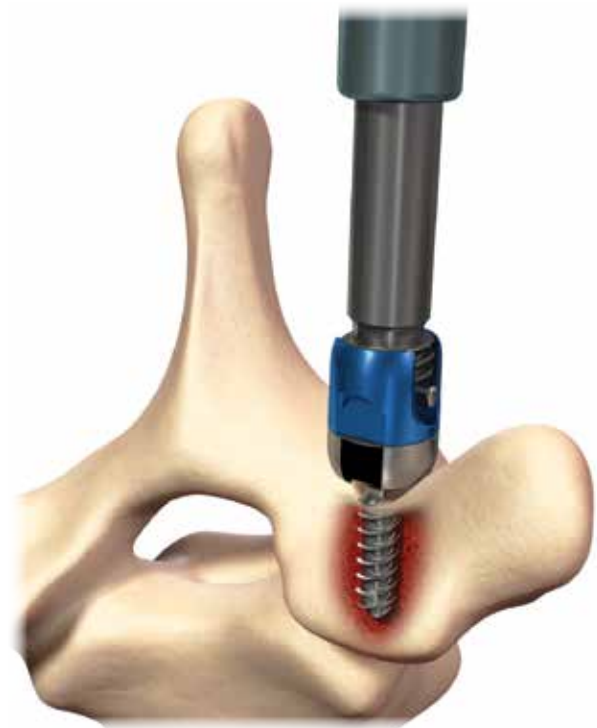

Figure 13
Polyaxial screw placement

STEP 9

- Drive the screw to the desired depth where polyaxial movement of the head is maintained.
- Remove the screw driver by rotating the knob counterclockwise until disengaged from the screw, then pull in the trajectory of the screw shank.
- Confirmation of screw position can be made using lateral and A/P radiographs or fluoroscopy. Place the remaining screws using a similar technique (Figure 13).

Note: When advancing the screw, avoid placing free hand on the knob, thus causing the screw driver to disconnect from the screw. To prevent this, place free hand on the blue outer sleeve of the polyaxial screw driver.

Note: The button on the knob of the driver is for instrument disassembly/cleaning only.

Note: A smooth shank screw implant option can be used to minimize tissue irritation.



Figure 14

Optional: Polyaxial screw height adjustment

STEP 10

- The tapered hex driver may be used to reposition the polyaxial screw. This instrument engages the hex of the screw shank and does not require threading into the tulip head (Figure 14).



Figure 15

Polyaxial screw head alignment

STEP 11

- Align the heads of the screws by engaging the distal end of the polyaxial screw head turner into the housing head of the screw. Rotate the blue handle until the desired orientation is reached (Figure 15).

Important: Use the blue portion of the instrument to rotate the upper housing.

VIRAGE OCT SPINAL FIXATION SYSTEM (*continued*)

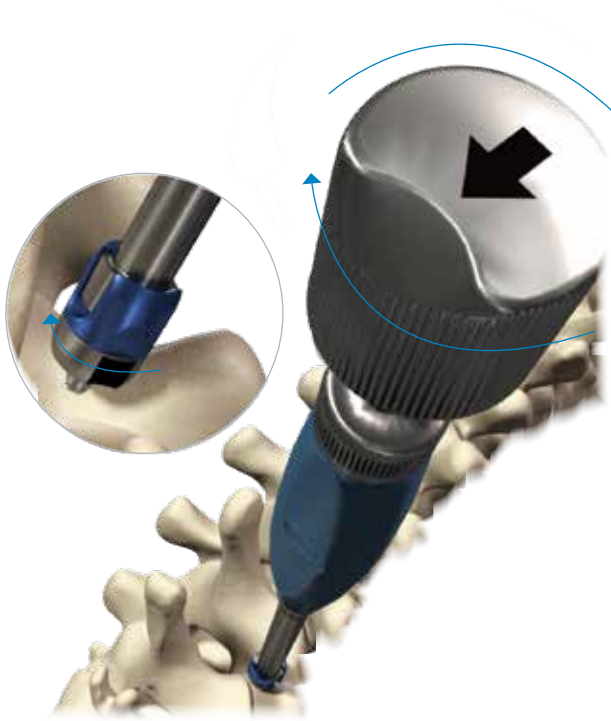

Figure 16
Adjusting direction of extreme angle

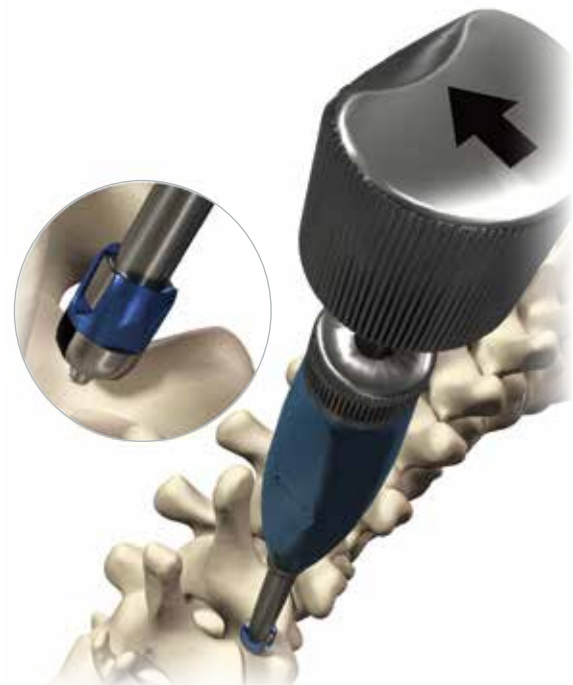

Figure 17
Engaging screw head turner

STEP 12

- All Virage System polyaxial screws allow for a 360° unconstrained range of motion providing 56° of angulation in all directions.
- To reach extreme angulation, slowly rotate the silver knob while applying downward pressure until the distal tip engages into the housing of the screw. Tactile/audible feedback confirms engagement. A black stripe on the screw's lower housing indicates extreme angle location (Figure 16).
- To rotate the direction of the extreme angle, turn the silver knob and point the arrow in the desired direction. If needed, align upper housing for rod placement by rotating the blue handle of the polyaxial screw head turner (Figure 17).

Note: If polyaxial screw movement is restricted, adjust the height of the screw.



Figure 18
Hook trial/insertion

STEP 13

- Identify which landmarks of the cervical lamina will receive hooks. Remove soft tissue and ligamentous connections sparingly, providing good visualization of the entire lamina and margins of the spinal canal.
- Place the hook trial on the lamina to identify the appropriate implant size.
- Prepare the lamina taking care not to remove excess material.
- When placing both the trial and the implant, take care not to breach the margins of the spinal cord (Figure 18).



Figure 19
Hook attachment

STEP 14

- Attach the hook forceps to the proximal body of the hook.
- Slide the hook underneath the lamina at the previously prepared position.
- Secure the hook to the cervical lamina. Place all remaining hooks using the same procedure (Figure 19).

Note: The closure top, closure top starter, and final driver may be passed through the hook forceps.

VIRAGE OCT SPINAL FIXATION SYSTEM (*continued*)



Figure 20
Rod preparation: Template

STEP 15

- A rod template may be used to determine the appropriate length and curvature of the rod (Figure 20).

Warning: Markings on the rod template are every 10mm.



Figure 21
Rod selection/cutting

STEP 16

- Choose the appropriate rod length and material. The Virage System contains pre-cut/pre-bent rods and straight rods. The titanium rods are colored blue and the cobalt chrome rods are silver. Cobalt chrome alloy offers increased strength and stiffness over titanium alloy.
- If cutting is needed, use the rod cutter. Rotate the knurled wheel until the two arrows are aligned. Insert the rod into appropriate labeled hole of the rod cutter to the desired depth. Repeatedly squeeze the handles until the rod is cut (Figure 21).

Note: Realigning arrows will assist in removal of the rod.

Note: The “cutting line” marks the spot where the rod cutter will cut the rod. The cutting line is located ~8mm from the face of the instrument.



Figure 22
Rod contouring

STEP 17

- If contouring is needed, use the french rod bender.
- Place the rod within the french rod bender and squeeze the handles to achieve the desired curvature.
- The french rod bender allows three different bend radii. To adjust, pull the center knob and turn to select the desired bend radius.

Note: Reverse bending can weaken the rod and is not recommended.

- If *in situ* bending is needed, rods can be contoured in the sagittal plane with the three *in situ* rod benders (Figure 22).



Figure 23
Rod placement

STEP 18

- Grasp the rod with the rod holder and engage the locking mechanism by fully closing the handles.
- To release, squeeze handles together, disengaging the locking mechanism (Figure 23).

VIRAGE OCT SPINAL FIXATION SYSTEM (*continued*)

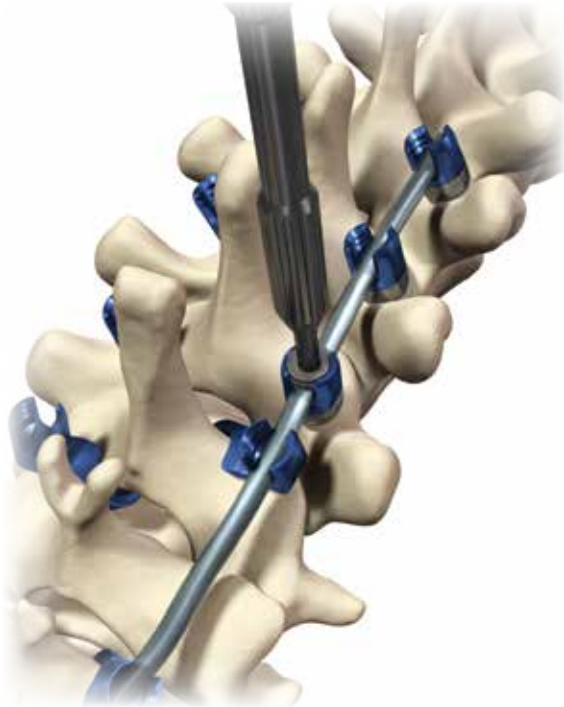

Figure 24
Closure top insertion

STEP 19

- Insert the closure top using the closure top starter and provisionally tighten into each screw/hook housing (Figure 24).
- Ensure that the rod and screw housing are perpendicular to each other when provisionally tightening closure top to avoid off axis tightening.
- If excessive force is needed to capture the rod into the polyaxial screw or hook, the rod should be recontoured.

Warning: Use care to avoid cross threading and off axis tightening which may result in improper locking of the construct.

Note: There are two instruments available to start closure tops. The standard closure top starter instrument has a double-ended retention feature for closure tops. An optional instrument is a provisional closure top driver that has a single-ended retention feature with a screw driver type handle.

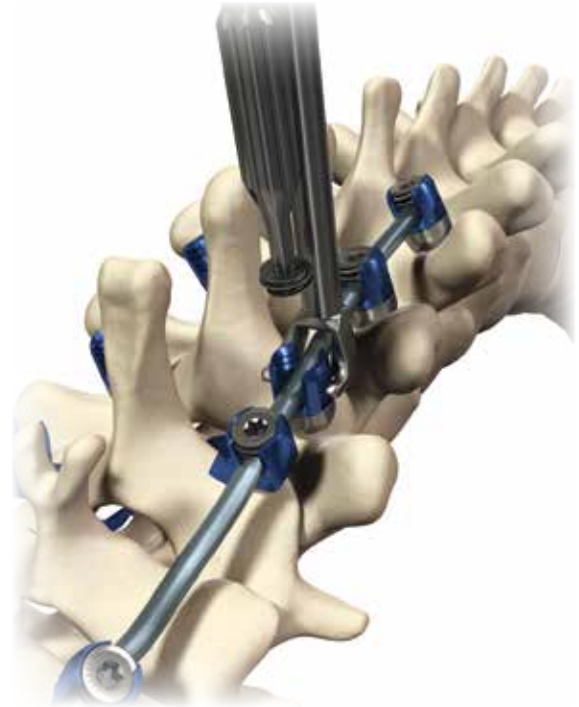

Figure 25
Rod reduction using rod rocker

STEP 20

- The rod rocker may be used to seat the rod and ease closure top introduction.
- Engage the rod rocker and gently tilt to lower the rod into the implant housing.
- Place the closure top with the closure top starter to secure the rod (Figure 25).

Warning: Do not attempt to reduce the rod using the closure top; always use reduction instrumentation to reduce the rod.



Figure 26
Closure top insertion through kerrison reducer



Figure 27
Rod reduction using kerrison rod reducer

STEP 21

- Prior to use, open the lock of the kerrison rod reducer and engage onto screw housing by applying a slight downward force until fully seated.
- Gently squeeze the handle to engage the screw head and seat the rod into the screw.
- Once seated, insert a closure top using a closure top starter through the kerrison rod reducer (Figure 26).
- To remove the kerrison rod reducer, disengage the lock to allow the handle to open fully; rotate slightly to either side and gently pull (Figure 27).

Note: Reduction travel is indicated by laser markings on the side of the kerrison rod reducer.

VIRAGE OCT SPINAL FIXATION SYSTEM (*continued*)



Figure 28
Closure top insertion through tower rod reducer



Figure 29
Rod reduction using tower rod reducer

STEP 22

- Prior to use, ensure the tower rod reducer is fully open by turning the large knob counterclockwise until positive stop is reached.
 - Engage the tower rod reducer onto the screw housing by applying a slight downward force until fully seated. Turn the large knob to seat the rod into the screw (Figure 28).
 - Once seated, insert a closure top using a closure top starter through the tower rod reducer.
 - To remove the tower rod reducer, turn the knob counterclockwise until it reaches the positive stop; rotate slightly to either side and gently pull (Figure 29).
- Note:** Reduction travel is indicated by laser markings on the side of the reducer.



Figure 30
Compression and distraction

STEP 23

- Once the rod is secured into the implants, distraction and/or compression may be performed to place the implants in their final position (Figure 30).
- A rod gripper is also included for additional rod manipulation.

Note: To disengage the rod gripper, press and hold the button until fully disengaged.



Figure 31
Final tightening

STEP 24

- When all implants are securely in place and the rods are fully seated, final tightening is performed. Tighten closure tops using the final driver, torque-limiting handle, and inline counter torque.
- Turn the torque-limiting handle clockwise to advance the closure top until two clicks are heard (Figure 31).

Note: Ensure the final driver is fully seated into the torque-limiting handle.

Note: Ensure that the rod and screw housing are perpendicular to each other when final tightening closure top to avoid off axis tightening.

Note: Final closure top driver does not have a retention feature for closure tops. Use a closure top starter or provisional closure top driver to insert & remove closure tops safely.

VIRAGE OCT SPINAL FIXATION SYSTEM (*continued*)

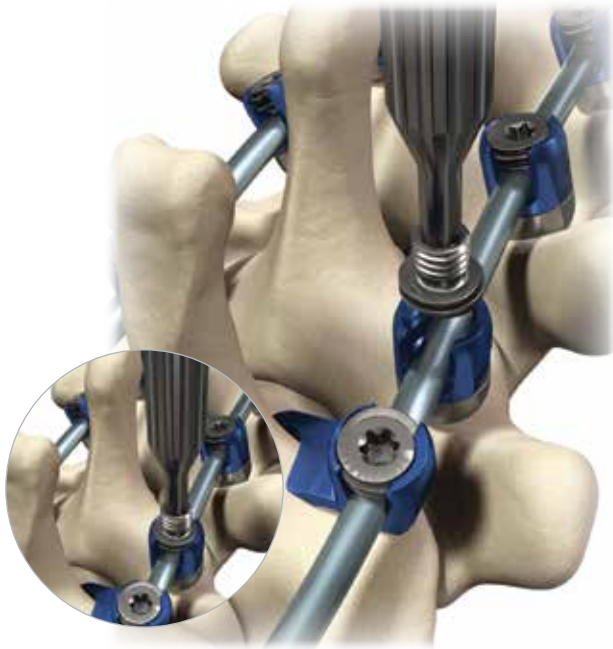

Figure 32
Transverse connector placement



Figure 33
Measuring for transverse connectors

STEP 25

- The Virage System includes head to head transverse connectors (HHTC) from 27 mm to 53mm. The HHTC is composed of three components: HHTC closure top, arm, and dome nut.
- The HHTC can accommodate housing tilt up to 20° (10° each side) requiring less bending of the HHTC arm and allowing off axis screw head position.
- Insert an HHTC closure top (07.01719.001) into the head of the applicable polyaxial screw using a closure top starter (Figure 32).
- Final tighten the HHTC closure top using the final driver, torque-limiting handle, and inline counter torque. Repeat on the contralateral side.
- Turn the torque-limiting handle clockwise to advance the closure top until two clicks are heard.

- Determine the appropriate size HHTC arm using the transverse connector caliper. Place both tips of the caliper into the HHTC closure top. Read the length and/or color coding on the caliper to determine appropriate HHTC size (Figure 33).
- HHTC arms are adjustable and available in multiple sizes:

SIZE	LENGTHS	TRAY COLOR
Extra Small	27 mm–33 mm	Gold
Small	32 mm–38 mm	Magenta
Medium	37 mm–43 mm	Green
Large	42 mm–48 mm	Light Blue
Extra Large	47 mm–53 mm	Orange

Note: There is a 1 mm overlap between sizes.



Figure 34
Assembling head to head connector

STEP 26

- Place the HHTC arm over the HHTC closure tops and around the tops of the polyaxial screws.
- Once the HHTC arm is in position, insert the HHTC dome nut (07.01720.001) with the closure top starter; provisionally tighten. Repeat on the contralateral side (Figure 34).

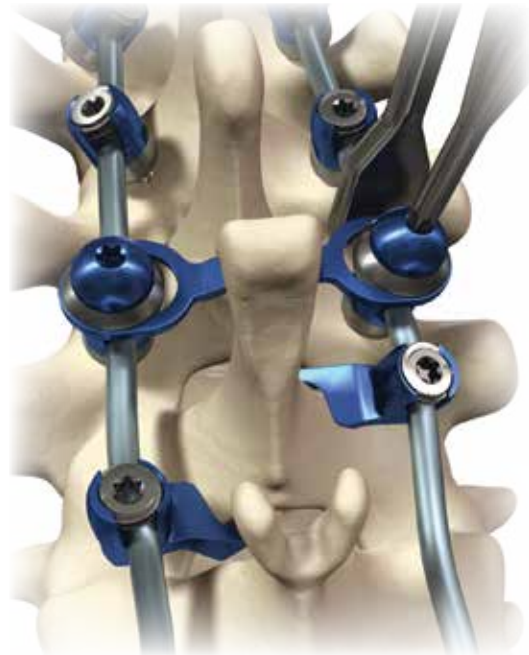

Figure 35
Final tightening

STEP 27

- Perform final tightening using the final driver and torque-limiting handle until two clicks are heard. Repeat on the contralateral side (Figure 35).

Note: The rod pusher is available to provide counter torque to the $\varnothing 3.5$ mm rod.

VIRAGE OCT SPINAL FIXATION SYSTEM (continued)



Figure 36
Measuring for transverse connectors

STEP 28

- Rod to rod transverse connectors (RRTC) are adjustable and available in multiple sizes:

SIZE	LENGTHS	TRAY COLOR
Extra Small	27 mm–33 mm	Gold
Small	32 mm–38 mm	Magenta
Medium	37 mm–43 mm	Green
Large	42 mm–48 mm	Light Blue
Extra Large	47 mm–53 mm	Orange

Note: There is a 1 mm overlap between sizes.

- Determine the appropriate size RRTC by using the transverse connector caliper.
- Place both tips of the caliper around lateral side of rods.
- Read the length and/or color coding on the caliper to determine appropriate RRTC size (see table above) (Figure 36).



Figure 37
Final tightening

STEP 29

- Engage the RRTC driver onto the RRTC hex nut.
- Position the RRTC onto the construct and snap it onto the rods using slight downward pressure. Repeat on the contralateral side.
- Attach the torque-limiting handle to the RRTC driver and final tighten by rotating clockwise until two clicks are heard (Figure 37).

Note: The rod pusher is available to provide counter torque to the $\varnothing 3.5$ mm rod.

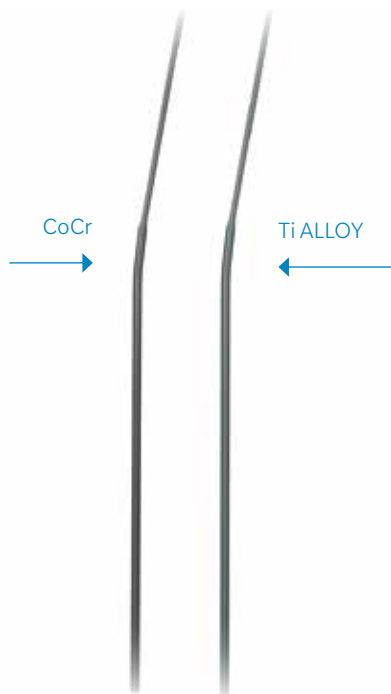

Figure 38
Transition rod placement $\varnothing 3.5$ mm/ $\varnothing 5.5$ mm transition rods

STEP 30

- Transition rods allow for a transition from the cervical to the thoracic spine or at any location where it is necessary to move from a $\varnothing 3.5$ mm rod to a $\varnothing 5.5$ mm rod (Figure 38).
- Titanium and cobalt chrome transition rods are offered pre-bent at the transition. Additional rod contouring and rod cutting may be accomplished using the french rod bender and/or rod cutter.

Caution: The start of the transition zone is indicated by a dark band. Do not connect implants within this transition zone.

Note: A $\varnothing 5.5$ mm rod cutter and bender will need to be ordered for the $\varnothing 5.5$ mm rod.

Note: Reverse bending can weaken the rod and is not recommended.



Figure 39
Rod connector placement and final tightening



Figure 40
Rod connector placement and final tightening

STEP 31

- The Virage System offers closed rod connectors to connect a $\varnothing 3.5$ mm rod to a $\varnothing 5.5$ mm titanium rod of the Zimmer Biomet Instinct™ Java™ Spinal Fixation System or Sequoia™ Pedicle Screw System.
- The closed rod connector contains two internal set screws that require locking using the final driver connected to the torque-limiting handle (Figure 39).
Note: A rod pusher is available to provide counter torque to the $\varnothing 3.5$ mm rod.
- The open rod connector can be inserted onto an existing $\varnothing 5.5$ mm Instinct Java or Sequoia construct or $\varnothing 3.5$ mm Virage OCT Spinal Fixation System construct.
- Final tighten both set screws with the final driver connected to the torque-limiting handle. A rod pusher is available to provide counter torque to the $\varnothing 3.5$ mm rod (Figure 40).

VIRAGE OCT SPINAL FIXATION SYSTEM (*continued*)



Figure 41
Lateral offset connector placement

STEP 32

- Lateral offset connectors offer medial-lateral flexibility in challenging rod/screw alignment situations.
- The Virage System offers two lengths of lateral offset connectors: 10 mm and 25 mm.
- Final tighten the closure top and set screw using the final driver connected to the torque-limiting handle (Figure 41).

Note: A rod pusher is available to provide counter torque to the $\varnothing 3.5$ mm rod.

Caution: Ensure the closure top is secured against the flat of the lateral offset connector arm.

Note: The lateral offset connector can either be bent or cut using the *in situ* benders or rod cutter (use $\varnothing 3.8$ opening).



Figure 42
Final construct

STEP 33

- Repeat final tightening of all connections of the final construct. An intraoperative radiographic image of the final construct should be made to confirm the desired construct is achieved prior to wound closure (Figure 42).

VIRAGE OCCIPITOCERVICAL

The following Surgical Technique describes the recommended placement and use of Virage Occipitocervical Spinal System components.

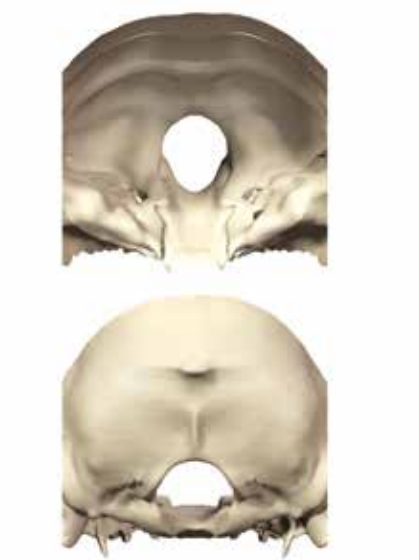

Figure 43
Occipital landmarks

STEP 1

- In general, the thickest bone in the sub occipital region is the occipital keel (internal occipital protuberance), near the midline. When positioning the occipital plate, it should be centered on the midline between the External Occipital Protuberance (EOP) and the posterior border of the foramen magnum. The goal is to maximize bone purchase (closer to EOP) while achieving a low profile (Figure 43).

Warning: Care should be taken during bone preparation to avoid damage to the occiput and to the surgical instruments.



Figure 44
Occipital plate selection

STEP 2

- The Virage System offers three occipital plates to accommodate patient anatomy:

SIZE	WIDTHS
Small	24 mm–33 mm
Medium	32 mm–41 mm
Large	40 mm–49 mm

Note: There is a 1mm overlap between sizes.

- Each plate size has three midline holes and two lateral holes for occipital fixation. Placement of as many screws as possible is recommended. A minimum of two screws must be used; a minimum of three screws must be used if the plate is bent, including one screw in the superior hole. The occipital plates include rod connector housings that rotate up to 40° to ease rod placement (Figure 44).

VIRAGE OCCIPITOCERVICAL (continued)



Figure 45
Occipital screw selection

STEP 2 (continued)

- The Virage System occipital screws are available in diameters of 4.5 mm and 5.25 mm (Figure 45). Refer to the table below:

DIAMETER	LENGTH	INCREMENTS	COLOR
ø4.5 mm	6 mm–16 mm	Every 2 mm	Light Blue
ø5.25 mm	6 mm–16 mm	Every 2 mm	Gold



Figure 46
Occipital plate contouring

STEP 3

- The Virage System occipital plate can be contoured to fit a patient's anatomy using the occipital plate bender at the plate's one bend zone at the superior hole. Reference the bend direction on the distal end of the plate bender. Ensure the plate bender is aligned with bend zone features by positioning the entire length of the plate's groove in the plate bender's center tip feature. Prior to bending, verify positive engagement visually and confirm by attempting to manipulate the plate in an alternating clockwise and counterclockwise fashion. A properly aligned plate/plate bender will not allow for any relative motion between the two devices (Figure 46).

Warning: Bending the plate outside of the bend zone groove may result in cracking of the plate. The surgeon should always inspect the plate before implanting.

Warning: Do not reverse bend the plate. Reverse bending may result in a projectile fracture of the plate.

Note: The plate may be bent up to 12° in either direction.



Figure 47
Occipital drill guide

STEP 4

- Three occipital drill/tap guides are available and each has a 2mm depth adjustment feature (6 mm/ 8 mm, 10 mm/12 mm, and 14 mm/16 mm).
- Select the appropriate occipital drill/tap guide and connect to the 3/16" handle. Engage the distal tip of the occipital drill/tap guide into the desired plate screw hole by pressing down until fully seated.
- Verify drill/tap depth by reading the depth markings on the top surface of the occipital drill/tap guide (Figure 47).

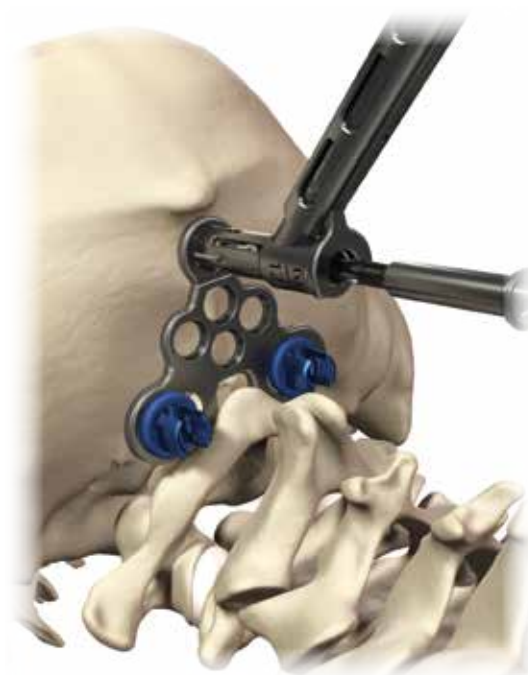

Figure 48
Occipital drilling

STEP 5

- Attach the $\varnothing 3.5$ mm flexible or rigid occipital drill to the A-O handle and place through the occipital drill/tap guide; drill to the desired depth (Figure 48).

Warning: Care should be taken during bone preparation to avoid penetrating too deep.

VIRAGE OCT OCCIPITOCERVICAL (*continued*)

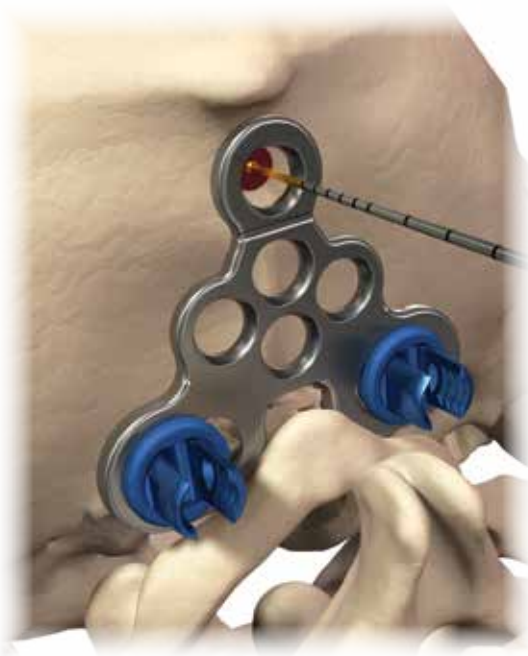

Figure 49
Verify hole integrity and depth

STEP 6

- Confirm bone integrity and measure hole depth using the sounding probe (Figure 49).

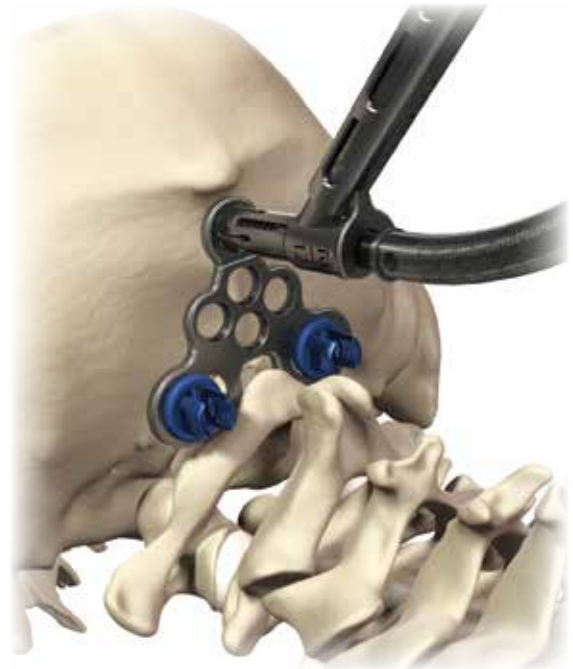

Figure 50
Tapping

STEP 7

- Attach the $\varnothing 3.5$ mm flexible or rigid occipital tap to the A-O handle and place through the appropriate occipital drill/tap guide; tap to the desired depth (Figure 50).

Note: Both the flexible and rigid taps must be used in conjunction with the guide to achieve the desired depth.

Note: Tapping is required as the occipital bone screws are not self-tapping.



Figure 51
Screw placement

STEP 8

- Select and verify the appropriate diameter and length of the occipital screw. Insert the screw using either the rigid or flexible hex driver.

Warning: Care should be taken to ensure the occipital screw is not driven in too deep.

- Ensure all screws are fully seated once the construct is assembled. An allen hex wrench is available if the patient's anatomy does not accommodate a rigid or flexible driver (Figure 51).

Note: When using the flexible driver, the occipital counter torque may be used to maintain driver/screw alignment during driver insertion and removal.



Figure 52
Occipital strap option

STEP 9 (optional)

- Prepare lateral holes of the occipital strap in the same manner as occipital plate holes (i.e., drill depth equals bone screw length).
- For the center hole, select an occipital bone screw that is 2 mm longer than the drill and tap depth previously prepared before occipital strap placement (i.e., drill depth plus 2 mm equals bone screw length). A minimum of two screws must be placed in the lower portion of the plate if the strap is used (Figure 52).

Note: Do not drill the superior midline hole through the occipital plate and strap.

VIRAGE OCT OCCIPITOCERVICAL (continued)



Figure 53
Rod selection/rod cutting

STEP 10

- A rod template may be used to determine the appropriate length and curvature of the rod.
- The Virage System includes occipital rods in different configurations and materials: pre-contoured titanium, pre-contoured cobalt chrome, and adjustable titanium. Cut to length using the rod cutter (Figure 53).

Note: Markings on the rod template are every 10mm.



Figure 54
Rod contouring

STEP 11

- Contour the rod into the desired shape using the french rod bender, in situ rod benders, and/or tube bending features of the in situ rod benders (Figure 54).

Note: Reverse bending can weaken the rod and is not recommended.



Figure 55
Rod placement

STEP 12

- Grasp the rod with the rod holder and engage the locking mechanism by fully closing the handles. To release, squeeze the handles together, disengaging the locking mechanism.
- Provisionally tighten closure tops using the closure top starter or occipital final drivers (Figure 55).

Caution: Pre-contoured Virage System occipital rods transition from $\varnothing 3.5$ mm to $\varnothing 3.8$ mm. The start of the transition zone is indicated by a dark band. Do not connect implants within this transition zone.

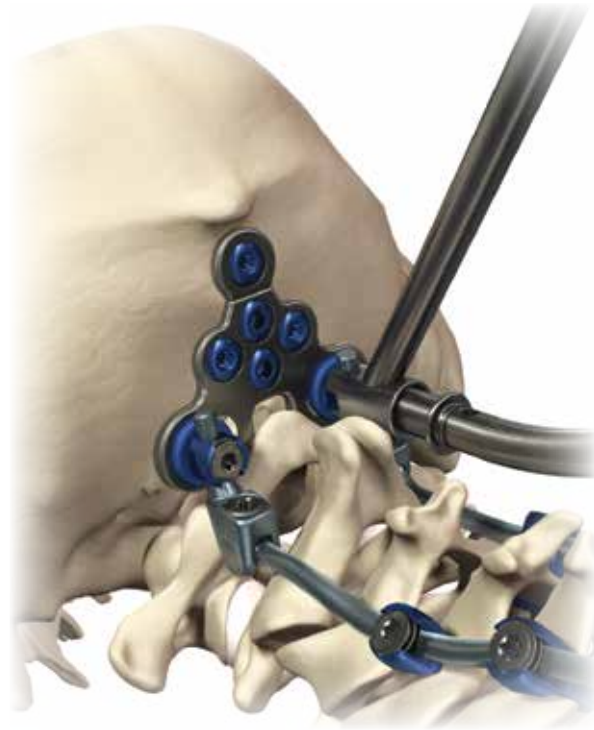

Figure 56
Final tightening

STEP 13

- Once all of the occipital screws have been secured, final tighten all closure tops and set screws using a final driver or occipital final driver (flexible or rigid), torque-limiting handle, and counter torque/rod pusher until two clicks are heard (Figure 56).

Note: Use the occipital counter torque when final tightening closure tops into the occipital plate housings.

Caution: Ensure the set screw of the adjustable occipital rod is final tightened.

VIRAGE OCT OCCIPITOCERVICAL (*continued*)

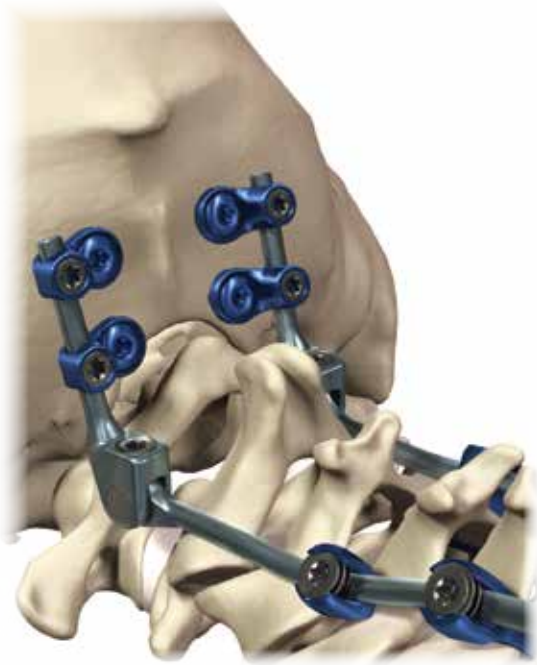

Figure 57
Occipital eyelet (optional)

STEP 14

- When occipital plate use is not possible or preferred, occipital eyelets are available as an alternative method of fixation. A minimum of two eyelets should be used on each rod. Slide eyelets over the rod and determine the desired bone screw location. Complete drill, tap, and screw placement steps as indicated for occipital plates. Once all of the occipital screws have been secured, final tighten set screws using an occipital final driver (flexible or rigid), torque-limiting handle, and occipital counter torque until two clicks are heard (Figure 57).

Note: The occipital counter torque does not fit over the occipital eyelets and must be used next to occipital eyelets along the $\varnothing 3.8$ mm rod segment.



Figure 58
Cable connectors (optional)

STEP 15

- Virage System cable connectors are available for connection to the titanium Lentur™ Cable System. Final tighten the set screw using the final driver and torque-limiting handle in conjunction with the rod pusher (Figure 58).



Figure 59

Final construct

STEP 16

- Recheck all connections of the final construct. An intraoperative radiographic image of the final construct should be made to confirm the desired construct is achieved prior to wound closure (Figure 59).

VIRAGE OCT INSTRUMENT DISASSEMBLY FOR CLEANING

After cleaning, reassemble by reversing instructions.

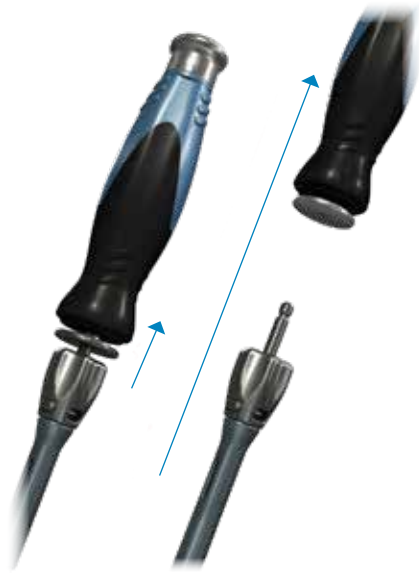

Figure 60
Polyaxial screw driver disassembly

STEP 1

- Pull back the collar on the A-O handle and disconnect it from the screw driver (Figure 60).



Figure 61
Polyaxial screw driver disassembly

STEP 2

- Depress the button and remove the screw driver shaft (Figure 61).



Figure 62
Polyaxial screw driver disassembly

STEP 3

- Pull the outer sleeve off of the screw driver (Figure 62).
- Flush all holes near the button (Figure 62, inset).

Note: After cleaning, reassemble the screw driver prior to sterilization. See assembly instructions in the Surgical Technique Guide.



Figure 63
Polyaxial screw head turner disassembly

STEP 4

- Turn the knob counterclockwise to disassemble (Figure 63).

VIRAGE OCT INSTRUMENT DISASSEMBLY FOR CLEANING (*continued*)



Figure 64
Polyaxial screw head turner disassembly

STEP 5

- Pull the inner shaft out of the outer shaft and separate (Figure 64).

Note: After cleaning, reassemble the polyaxial screw head turner prior to sterilization.



Figure 65
Tower rod reducer disassembly

STEP 6

- To disassemble, turn the knob clockwise until the inside shaft is free (Figure 65).

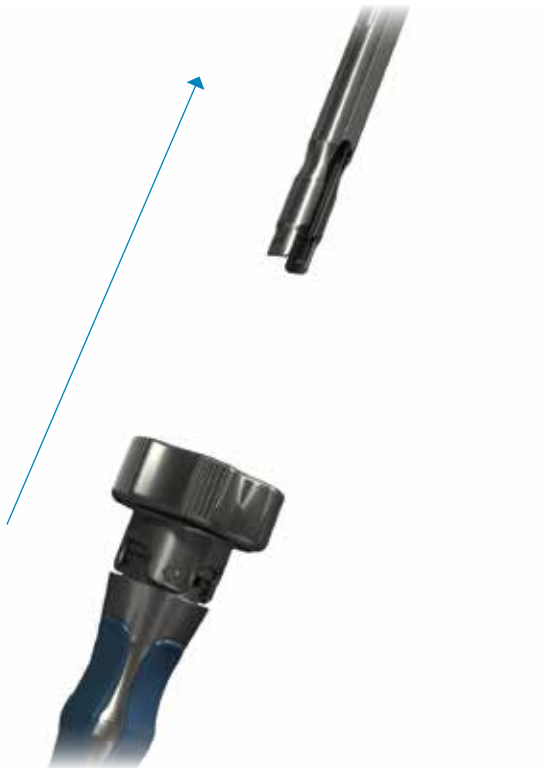

Figure 66
Tower rod reducer disassembly

STEP 7

- Pull the inside shaft to separate (Figure 66).



Figure 67
Tower rod reducer disassembly

STEP 8

- Turn the top knob and flush (Figure 67).

Note: After cleaning, reassemble the tower rod reducer prior to sterilization.

VIRAGE OCT REVISION AND REMOVAL STEPS

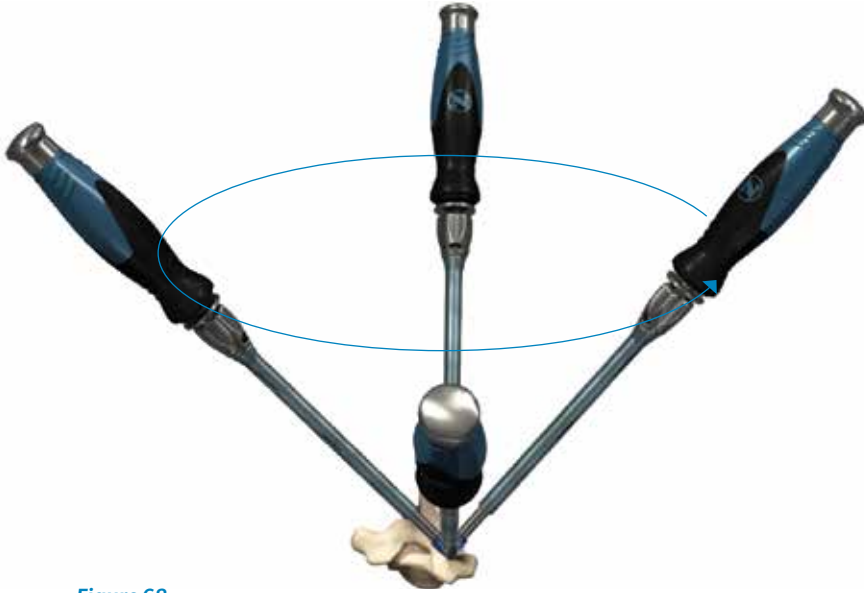

Figure 68

Re-engaging polyaxial screw driver

CERVICO-THORACIC SYSTEM CONSTRUCT REMOVAL

- Remove all closure tops and loosen set screws using the final driver, torque-limiting handle and inline counter torque/rod pusher.
- Remove rods from construct.
- Remove pedicle screws by fully engaging the screw driver and turning counterclockwise.
- If the hex portion of the screw cannot be re-engaged, utilize the polyaxial screw remover. To use, remove the polyaxial hex driver from polyaxial screw driver and replace with the polyaxial screw remover.
- Insert and tighten into the pedicle screw and rotate counterclockwise about the pedicle screw shank axis (Figure 68).

OCCIPITOCERVICAL SYSTEM CONSTRUCT REMOVAL

- Remove all closure tops and loosen all set screws using a final driver or occipital final driver (rigid or flexible).
- Remove all occipital bone screws using the 3 mm hex driver.
- Remove rods and occipital plate/eyelets from the construct.

KIT CONTENTS

Virage Standard Instruments, Kit Number: 07.01973.412

Instruments, Lower Tray

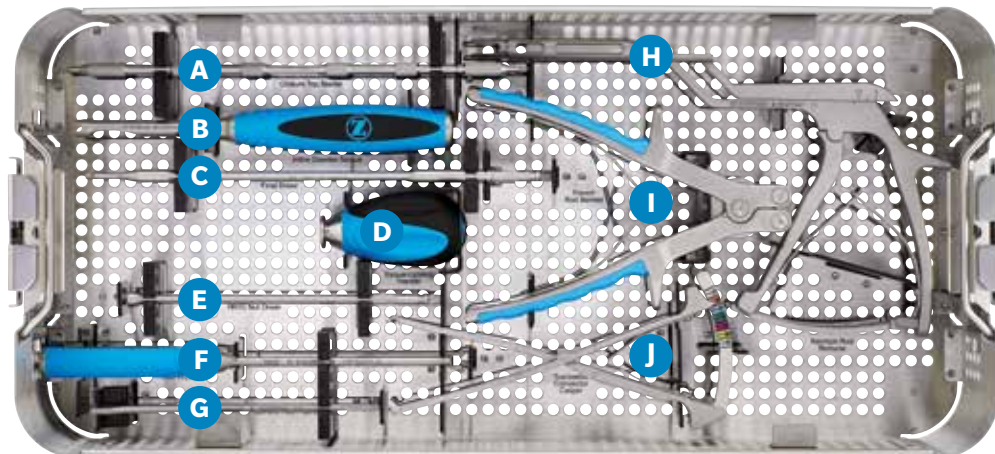

DESCRIPTION	QUANTITY	REFERENCE	PART NUMBER
French Rod Bender	1	I	07.01770.001
Rod Rocker	1	F	07.01775.001
Kerrison Rod Reducer	1	H	07.01777.001
Transverse Connector Caliper	1	J	07.01780.001
Transverse Connector Driver–Rod to Rod, 6 mm	2	E	07.01781.001
Closure Top Starter	2	A	07.01782.001
Closure Top Final Driver	2	C	07.01748.001
Rod Pusher	1	G	07.01784.001
Inline Counter Torque	1	B	07.01785.001
Torque-Limiting Handle, 3/16"	1	D	07.01792.001

KIT CONTENTS (continued)

Virage Standard Instruments, Kit Number: 07.01973.412

Instruments, Upper Tray

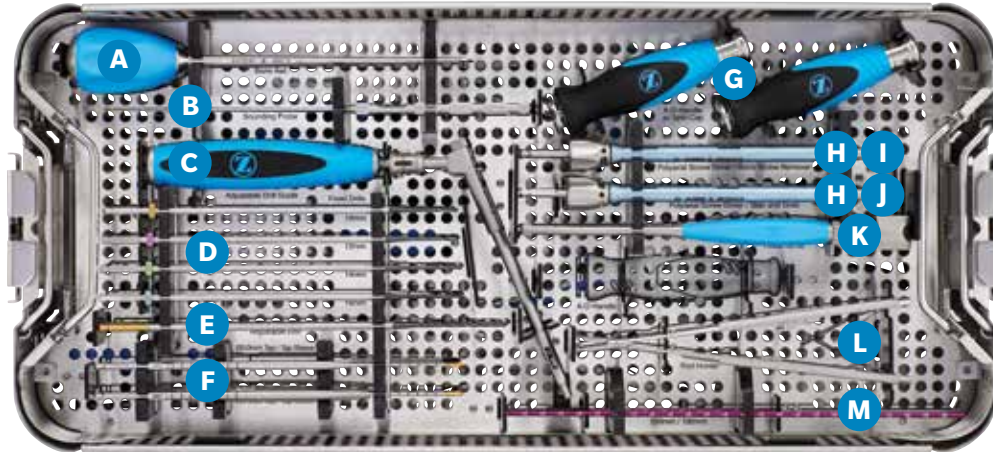

DESCRIPTION	QUANTITY	REFERENCE	PART NUMBER
Bone Awl, $\varnothing 2.0 \times 8$ mm	1	A	07.01752.001
Drill Guide	1	C	07.01755.001
Adjustable Drill, $\varnothing 2.3$ mm	2	E	07.01757.001
Fixed Drill, $\varnothing 2.3$ mm \times 10 mm	1	D	07.01758.001
Fixed Drill, $\varnothing 2.3$ mm \times 12 mm	1	D	07.01758.002
Fixed Drill, $\varnothing 2.3$ mm \times 14 mm	1	D	07.01758.003
Fixed Drill, $\varnothing 2.3$ mm \times 16 mm	1	D	07.01758.004
Sounding Probe	1	B	07.01759.001
Tap, Small, $\varnothing 3.0$ mm	1	F	07.01761.001
Tap, Small, $\varnothing 3.5$ mm	1	F	07.01761.002
Tap Sleeve, $\varnothing 3.5$ mm	1	F	07.01763.002
Polyaxial Screw Driver, Inner Sleeve	2	H (assembled)	07.01764.001
Polyaxial Hex Screw Driver, 2.5 mm	2	H (assembled)	07.01764.002
Polyaxial Screw Driver, Outer Sleeve	2	H (assembled)	07.01764.003
Tapered Hex Driver, 2.5 mm	1	J (under H)	07.01765.001
Polyaxial Screw Head Turner	1	K	07.01766.001
Rod Template, 100 mm	1	M	07.01767.001
Rod Template, 250 mm	1	M	07.01767.002
Rod Holder	1	L	07.01768.001
Polyaxial Screw Remover	1	I (under H)	07.01786.002
A-O Handle with Spin Cap	2	G	07.01788.001

Virage Standard Implants, Kit Number: 07.01973.411

Implant Tray

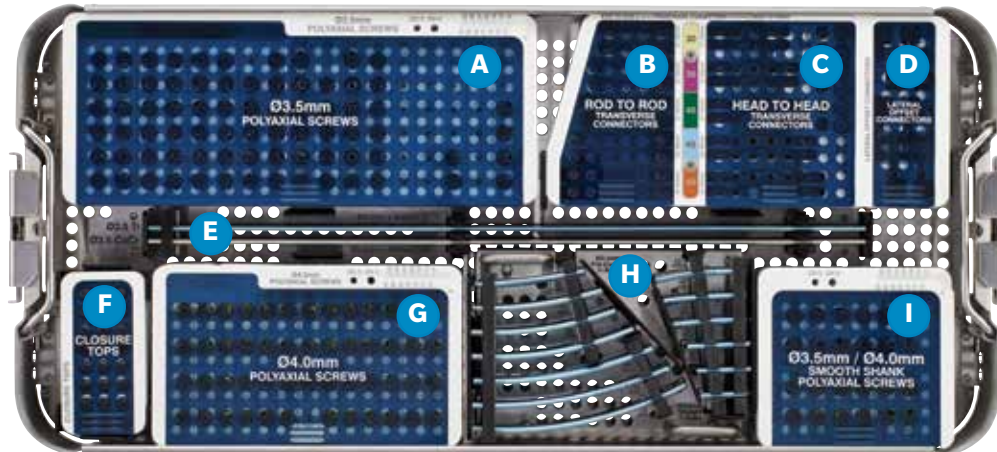
**ø3.5 Polyaxial Screw Caddy**

DESCRIPTION	QUANTITY	REF.	PART NUMBER
ø3.5 mm × 10 mm	10	A	07.01702.003
ø3.5 mm × 12 mm	12	A	07.01702.005
ø3.5 mm × 14 mm	12	A	07.01702.007
ø3.5 mm × 16 mm	8	A	07.01702.009
ø3.5 mm × 18 mm	4	A	07.01702.011
ø3.5 mm × 20 mm	4	A	07.01702.013
ø3.5 mm × 22 mm	4	A	07.01702.015
ø3.5 mm × 24 mm	2	A	07.01702.017
ø3.5 mm × 26 mm	2	A	07.01702.019
ø3.5 mm × 28 mm	2	A	07.01702.021
ø3.5 mm × 30 mm	2	A	07.01702.023
ø3.5 mm × 32 mm	2	A	07.01702.025
ø3.5 mm × 34 mm	2	A	07.01702.027

ø3.5 Polyaxial Smooth Shank Screw Caddy

ø3.5 mm × 24 mm	2	I	07.01707.003
ø3.5 mm × 26 mm	2	I	07.01707.005
ø3.5 mm × 28 mm	2	I	07.01707.007
ø3.5 mm × 30 mm	2	I	07.01707.009
ø3.5 mm × 32 mm	2	I	07.01707.011
ø3.5 mm × 34 mm	2	I	07.01707.013

ø4.0 Polyaxial Screw Caddy

DESCRIPTION	QUANTITY	REF.	PART NUMBER
ø4.0 mm × 10 mm	4	G	07.01702.046
ø4.0 mm × 12 mm	4	G	07.01702.048
ø4.0 mm × 14 mm	4	G	07.01702.050
ø4.0 mm × 16 mm	4	G	07.01702.052
ø4.0 mm × 18 mm	2	G	07.01702.054
ø4.0 mm × 20 mm	2	G	07.01702.056
ø4.0 mm × 22 mm	2	G	07.01702.058
ø4.0 mm × 24 mm	2	G	07.01702.060
ø4.0 mm × 26 mm	2	G	07.01702.062
ø4.0 mm × 28 mm	2	G	07.01702.064
ø4.0 mm × 30 mm	2	G	07.01702.066
ø4.0 mm × 32 mm	2	G	07.01702.068
ø4.0 mm × 34 mm	2	G	07.01702.070

ø4.0 Polyaxial Smooth Shank Screw Caddy

ø4.0 mm × 24 mm	2	I	07.01707.022
ø4.0 mm × 26 mm	2	I	07.01707.024
ø4.0 mm × 28 mm	2	I	07.01707.026
ø4.0 mm × 30 mm	2	I	07.01707.028
ø4.0 mm × 32 mm	2	I	07.01707.030
ø4.0 mm × 34 mm	2	I	07.01707.032

KIT CONTENTS (continued)

Virage Standard Implants, Kit Number: 07.01973.411

Implant Tray (continued)

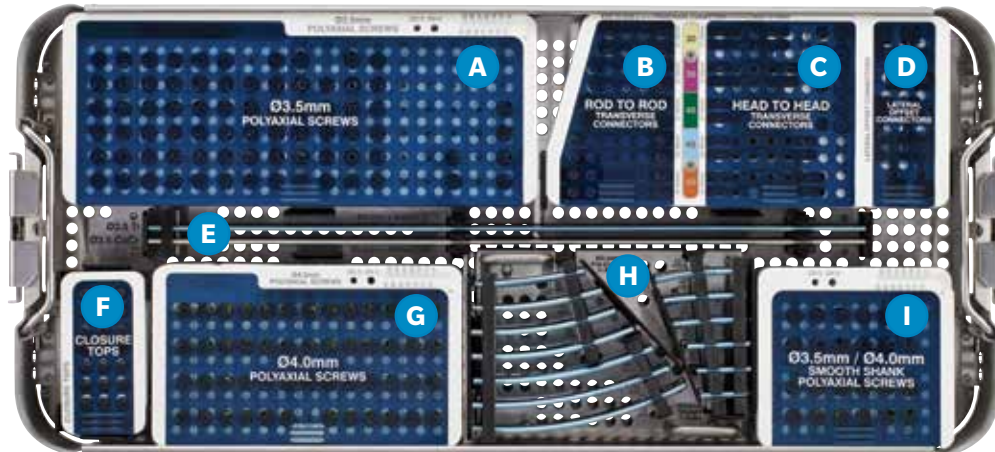

Rod Caddy (07-01811-014)

Straight Rods

DESCRIPTION	QUANTITY	REF.	PART NUMBER
Ti, ø3.5 mm × 25 mm	2	H	07.01709.002
Ti, ø3.5 mm × 30 mm	2	H	07.01709.003
Ti, ø3.5 mm × 35 mm	2	H	07.01709.004
Ti, ø3.5 mm × 400 mm	2	E	07.01709.006
CoCr, ø3.5 mm × 400 mm	2	E	07.01715.002

Curved Rods

DESCRIPTION	QUANTITY	REF.	PART NUMBER
Ti, ø3.5 mm × 40 mm	2	H	07.01710.001
Ti, ø3.5 mm × 45 mm	2	H	07.01710.002
Ti, ø3.5 mm × 50 mm	2	H	07.01710.003
Ti, ø3.5 mm × 60 mm	2	H	07.01710.005
Ti, ø3.5 mm × 70 mm	2	H	07.01710.007
Ti, ø3.5 mm × 80 mm	2	H	07.01710.009
Ti, ø3.5 mm × 90 mm	2	H	07.01710.011
Ti, ø3.5 mm × 100 mm	2	H	07.01710.012
Ti, ø3.5 mm × 110 mm	2	H	07.01710.013
Ti, ø3.5 mm × 120 mm	2	H	07.01710.014

Lateral Offset and Transverse Connector Caddy (07.01811.010)

Head to Head Transverse Connector, 30 mm	1	C	07.01717.002
Head to Head Transverse Connector, 35 mm	1	C	07.01717.003
Head to Head Transverse Connector, 40 mm	1	C	07.01717.004
Head to Head Transverse Connector, 45 mm	1	C	07.01717.005
Head to Head Transverse Connector, 50 mm	1	C	07.01717.006
Head to Head Transverse Connector Closure Top	6	C	07.01719.001
Head to Head Transverse Connector Dome Nut	6	C	07.01720.001

Rod to Rod Transverse Connector, 30 mm	1	B	07.01721.002
Rod to Rod Transverse Connector, 35 mm	1	B	07.01721.003
Rod to Rod Transverse Connector, 40 mm	1	B	07.01721.004
Rod to Rod Transverse Connector, 45 mm	1	B	07.01721.005
Rod to Rod Transverse Connector, 50 mm	1	B	07.01721.006
Lateral Offset Connector, 10 mm	2	D	07.01727.001
Lateral Offset Connector, 25 mm	2	D	07.01727.002

Closure Top Caddy

Standard Closure Top	24	F	07-01728-001
----------------------	----	---	--------------

Virage CT Junction Implants and Instruments, Kit Number: 07.01973.430

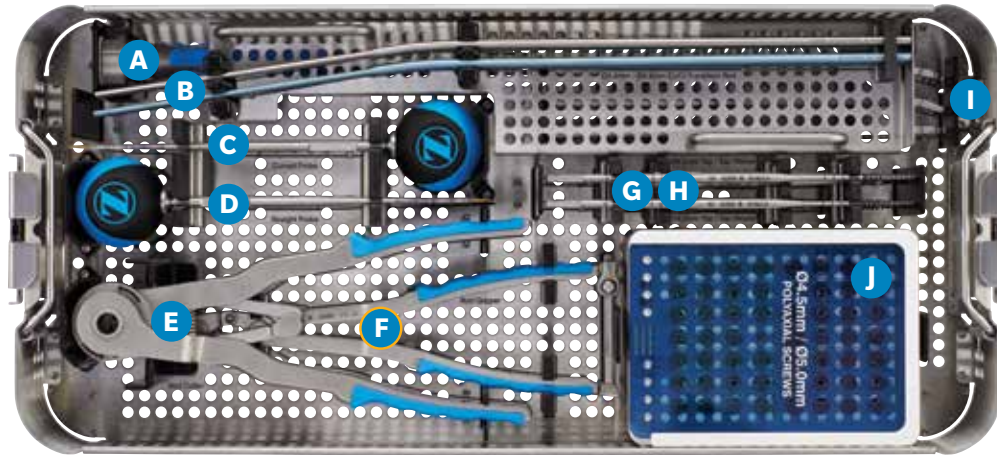

DESCRIPTION	QUANTITY	REF.	PART NUMBER
Curved Probe	1	C	07.01753.001
Straight Probe	1	D	07.01754.001
Tap, Large, ø4.0 mm	1	G	07.01762.001
Tap, Large, ø4.5 mm	1	G	07.01762.002
ø4.5 mm Tap Sleeve	1	H	07.01763.004
Rod Gripper	1	F	07.01769.001
<i>In situ</i> Rod Bender, Left	1	I	07.01771.002
<i>In situ</i> Rod Bender, Right	1	I	07.01772.002
<i>In situ</i> Rod Bender, Straight	1	I	07.01773.002
Rod Cutter, Ratcheting	1	E	07.01774.001
Tower Rod Reducer	1	A	07.01776.001

Polyaxial Screw Caddy

ø4.5 mm × 20 mm	4	J	07.01708.002
ø4.5 mm × 25 mm	4	J	07.01708.003
ø4.5 mm × 30 mm	4	J	07.01708.004
ø4.5 mm × 35 mm	4	J	07.01708.005
ø4.5 mm × 40 mm	2	J	07.01708.006
ø4.5 mm × 45 mm	2	J	07.01708.007

DESCRIPTION	QUANTITY	REF.	PART NUMBER
Transition Ti Rod ø3.5 mm/ø5.5 mm × 450 mm	3	B	07.01714.001
Transition CoCr Rod ø3.5 mm/ø5.5 mm × 450 mm	3	B	07.01716.001

ø5.0 mm × 20 mm	2	J	07.01708.010
ø5.0 mm × 25 mm	4	J	07.01708.011
ø5.0 mm × 30 mm	4	J	07.01708.012
ø5.0 mm × 35 mm	4	J	07.01708.013
ø5.0 mm × 40 mm	2	J	07.01708.014
ø5.0 mm × 45 mm	2	J	07.01708.015

KIT CONTENTS (continued)

Virage OCT Deluxe Implants and Instruments, Kit Number: 07.01973.402

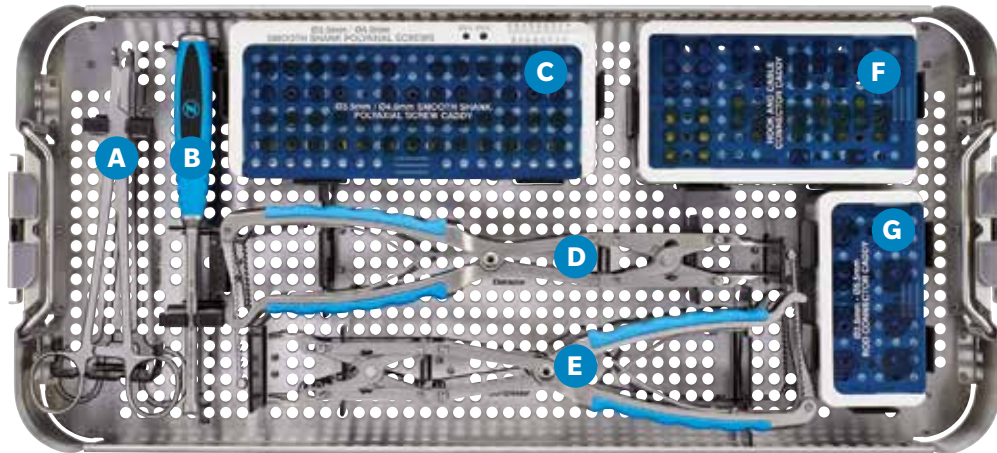

DESCRIPTION	QUANTITY	REF.	PART NUMBER
Hook Trial, 8 mm	1	B	07.01750.001
Hook Forceps	1	A	07.01751.001
Compressor	1	E	07.01778.001
Distractor	1	D	07.01779.001

Polyaxial Smooth Shank Screw Caddy

DESCRIPTION	QUANTITY	REF.	PART NUMBER
ø3.5 mm × 22 mm	2	C	07.01707.001
ø3.5 mm × 24 mm	2	C	07.01707.003
ø3.5 mm × 26 mm	2	C	07.01707.005
ø3.5 mm × 28 mm	2	C	07.01707.007
ø3.5 mm × 30 mm	2	C	07.01707.009
ø3.5 mm × 32 mm	2	C	07.01707.011
ø3.5 mm × 34 mm	2	C	07.01707.013
ø3.5 mm × 36 mm	2	C	07.01707.015
ø3.5 mm × 38 mm	2	C	07.01707.017
ø3.5 mm × 40 mm	2	C	07.01707.019

DESCRIPTION	QUANTITY	REF.	PART NUMBER
ø4.0 mm × 22 mm	2	C	07.01707.020
ø4.0 mm × 24 mm	2	C	07.01707.022
ø4.0 mm × 26 mm	2	C	07.01707.024
ø4.0 mm × 28 mm	2	C	07.01707.026
ø4.0 mm × 30 mm	2	C	07.01707.028
ø4.0 mm × 32 mm	2	C	07.01707.030
ø4.0 mm × 34 mm	2	C	07.01707.032
ø4.0 mm × 36 mm	2	C	07.01707.034
ø4.0 mm × 38 mm	2	C	07.01707.036
ø4.0 mm × 40 mm	2	C	07.01707.038

Hook and Cable Connector Caddy

Laminar Hook, 6 mm	4	F	07.01697.002
Laminar Hook, 8 mm	4	F	07.01697.004
Cable Connector	2	F	07.01700.001

Offset Laminar Hook, Left, 6 mm	2	F	07.01698.002
Offset Laminar Hook, Left, 8 mm	2	F	07.01698.004
Offset Laminar Hook, Right, 6 mm	2	F	07.01699.002
Offset Laminar Hook, Right, 8 mm	2	F	07.01699.004

Rod Connector Caddy

DESCRIPTION	QUANTITY	REF.	PART NUMBER
Rod Connector, Closed ø3.5 mm–ø5.5 mm	4	G	07.01739.001

DESCRIPTION	QUANTITY	REF.	PART NUMBER
Rod Connector, Open ø3.5 mm–ø5.5 mm	4	G	07.01725.001

Virage Occipital Implants and Instruments, Kit Number: 07.01973.403

Lower Tray

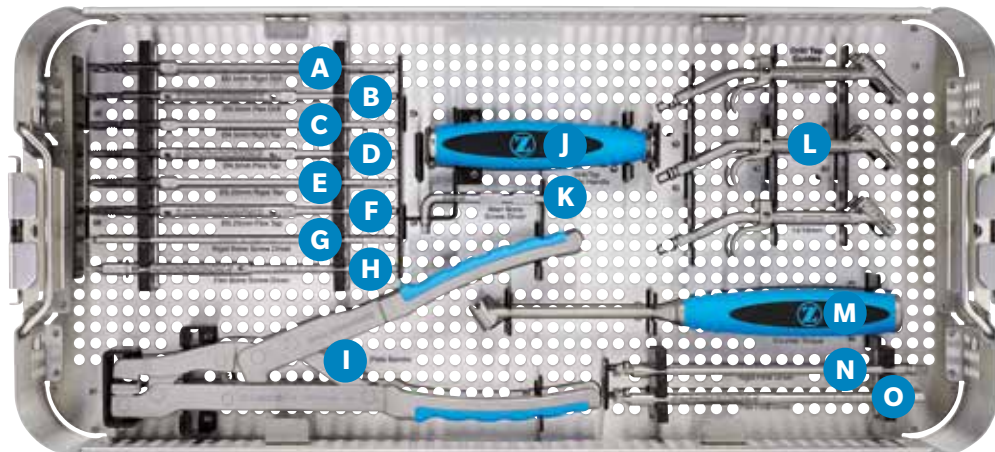

DESCRIPTION	QUANTITY	REFERENCE	PART NUMBER
Handle, 3/16"	1	J	07.01790.001
Occipital Drill/Tap Guide, 6 mm/8 mm	1	L	07.01793.001
Occipital Drill/Tap Guide, 10 mm/12 mm	1	L	07.01793.002
Occipital Drill/Tap Guide, 14 mm/16 mm	1	L	07.01793.003
Occipital Drill, Rigid, \varnothing 3.5 mm	1	A	07.01794.001
Occipital Drill, Flexible, \varnothing 3.5 mm	1	B	07.01795.001
Occipital Tap, Rigid, \varnothing 4.5 mm	1	C	07.01796.001
Occipital Tap, Rigid, \varnothing 5.25 mm	1	E	07.01796.002
Occipital Tap, Flexible, \varnothing 4.5 mm	1	D	07.01797.001
Occipital Tap, Flexible, \varnothing 5.25 mm	1	F	07.01797.002
Hex Driver, Rigid, 3 mm	1	G	07.01798.001
Hex Driver, Flexible, 3 mm	1	H	07.01799.001
Allen Hex Wrench, 3 mm	1	K	07.01801.001
Occipital Counter Torque	1	M	07.01802.001
Plate Bender	1	I	07.01803.001
Occipital Final Driver, Flexible	1	O	07.01804.001
Occipital Final Driver, Rigid	1	N	07.01805.001

KIT CONTENTS (continued)

Virage Occipital Implants and Instruments, Kit Number: 07.01973.403

Upper Tray

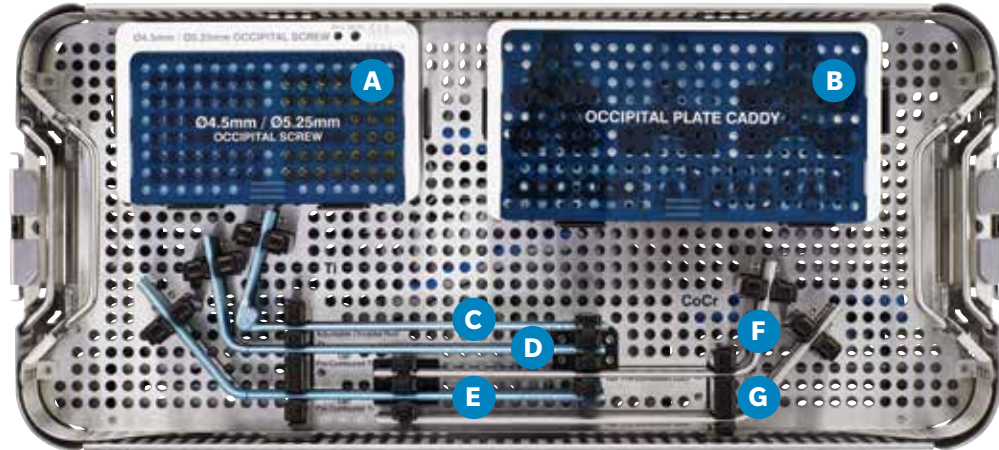

DESCRIPTION	QUANTITY	REFERENCE	PART NUMBER
Ti Occipital Rod, Adjustable	3	C	07.01711.001
Pre-Contoured Occipital Rod, Ti, 100°	2	D	07.01712.001
Pre-Contoured Occipital Rod, Ti, 130°	2	E	07.01712.003
Pre-Contoured Occipital Rod, CoCr, 100°	2	F	07.01713.001
Pre-Contoured Occipital Rod, CoCr, 130°	2	G	07.01713.003

Occipital Plate Caddy

DESCRIPTION	QUANTITY	REF.	PART NUMBER
Occipital Plate, Small	1	B	07.01693.004
Occipital Plate, Medium	2	B	07.01693.005
Occipital Plate, Large	1	B	07.01693.006

DESCRIPTION	QUANTITY	REF.	PART NUMBER
Occipital Strap	2	B	07.01694.001
Occipital Eyelet	6	B	07.01738.001

Occipital Screw Caddy

DESCRIPTION	QUANTITY	REF.	PART NUMBER
ø4.5 mm × 6 mm	5	A	07.01696.001
ø4.5 mm × 8 mm	5	A	07.01696.003
ø4.5 mm × 10 mm	5	A	07.01696.005
ø4.5 mm × 12 mm	5	A	07.01696.007
ø4.5 mm × 14 mm	5	A	07.01696.009
ø4.5 mm × 16 mm	5	A	07.01696.011

DESCRIPTION	QUANTITY	REF.	PART NUMBER
ø5.25 mm × 6 mm	2	A	07.01696.014
ø5.25 mm × 8 mm	2	A	07.01696.016
ø5.25 mm × 10 mm	2	A	07.01696.018
ø5.25 mm × 12 mm	2	A	07.01696.020
ø5.25 mm × 14 mm	2	A	07.01696.022
ø5.25 mm × 16 mm	2	A	07.01696.024

INSTRUMENT VISUAL GUIDE

Virage OCT Standard System Instruments



Bone Awl	PART NUMBER
ø2.0 x 8 mm	07.01752.001



Adjustable Drill, ø2.3 mm	PART NUMBER
	07.01757.001



Sounding Probe	PART NUMBER
	07.01759.001



Tap, Small	PART NUMBER
ø3.0 mm	07.01761.001
ø3.5 mm	07.01761.002



Assembled Screw Driver	PART NUMBER
Polyaxial Screw Driver, Inner Sleeve	07.01764.001
Polyaxial Hex Screw Driver, 2.5 mm	07.01764.002
Polyaxial Screw Driver, Outer Sleeve	07.01764.003



Polyaxial Screw Head Turner	PART NUMBER
	07.01766.001



Drill Guide	PART NUMBER
	07.01755.001



Fixed Drill	PART NUMBER
ø2.3 mm x 10 mm	07.01758.001
ø2.3 mm x 12 mm	07.01758.002
ø2.3 mm x 14 mm	07.01758.003
ø2.3 mm x 16 mm	07.01758.004



Tap Sleeve, ø3.5 mm	PART NUMBER
	07.01763.002



Tapered Hex Driver, 2.5 mm	PART NUMBER
	07.01765.001



Rod Template, 100 mm	PART NUMBER
	07.01767.001



Rod Template, 250 mm	PART NUMBER
	07.01767.002

INSTRUMENT VISUAL GUIDE *(continued)*

Virage CT Junction System Instruments



Rod Holder PART NUMBER
07.01768.001



Rod Rocker PART NUMBER
07.01775.001

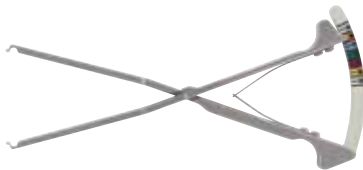

Transverse Connector Caliper PART NUMBER
07.01780.001



Closure Top Starter PART NUMBER
07.01782.001



Closure Top Starter- Single Ended PART NUMBER
07.01749.001



Rod Pusher PART NUMBER
07.01784.001



Polyaxial Screw Remover PART NUMBER
07.01786.001



Inline Counter Torque PART NUMBER
07.01785.001

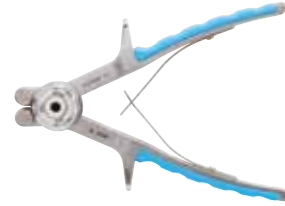

French Rod Bender PART NUMBER
07.01770.001



Transverse Connector Driver, Rod to Rod PART NUMBER
07.01781.001



Kerrison Rod Reducer PART NUMBER
07.01777.001



Closure Top Final Driver PART NUMBER
07.01748.001



Torque-Limiting Handle, 3/16" PART NUMBER
07.01792.001



A-O Handle with Spin Cap PART NUMBER
07.01788.001

Virage OCT CT Junction System Instruments (continued)



Curved Probe	PART NUMBER
	07.01753.001



Straight Probe	PART NUMBER
	07.01754.001



Tap, Large	PART NUMBER
ø4.0 mm	07.01762.001
ø4.5 mm	07.01762.002



ø4.5 mm Tap Sleeve	PART NUMBER
	07.01763.004



Rod Gripper	PART NUMBER
	07.01769.001



In Situ Rod Bender, Left	PART NUMBER
	07.01771.002



In Situ Rod Bender, Right	PART NUMBER
	07.01772.002



In Situ Rod Bender, Straight	PART NUMBER
	07.01773.002



Rod Cutter	PART NUMBER
	07.01774.001



Tower Rod Reducer	PART NUMBER
	07.01776.001

INSTRUMENT VISUAL GUIDE (continued)

Virage OCT Deluxe System Instruments



Hook Trial, 8 mm	PART NUMBER
	07.01750.001



Hook Forceps	PART NUMBER
	07.01751.001

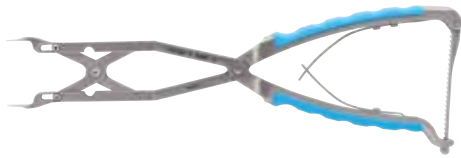

Compressor	PART NUMBER
	07.01778.001



Distractor	PART NUMBER
	07.01779.001

Virage Occipital System Instruments



Handle 3/16"	PART NUMBER
	07.01790.001



Occipital Drill, ø3.5 mm	PART NUMBER
Rigid	07.01794.001
Flexible	07.01795.001



Occipital Tap	PART NUMBER
Rigid, ø4.5 mm	07.01796.001
Rigid, ø5.25 mm	07.01796.002
Flexible, ø4.5 mm	07.01797.001
Flexible, ø5.25 mm	07.01797.002



Occipital Counter Torque	PART NUMBER
	07.01802.001



Occipital Final Driver	PART NUMBER
Flexible	07.01804.001
Rigid	07.01805.001



Occipital Drill/Tap Guide	PART NUMBER
6 mm/8 mm	07.01793.001
10 mm/12 mm	07.01793.002
14 mm/16 mm	07.01793.003



Hex Driver, 3 mm	PART NUMBER
Rigid	07.01798.001
Flexible	07.01799.001



Allen Hex Wrench, 3 mm	PART NUMBER
	07.01801.001



Plate Bender	PART NUMBER
	07.01803.001

IMPORTANT INFORMATION ON VIRAGE OCT SPINAL FIXATION SYSTEM

Device Description

The Virage OCT Spinal Fixation System is a posterior system intended for the Occipital-Cervical-Thoracic spine (Occiput–T3). The system consists of a variety of rods, anchors, transverse connectors, screws, and polyaxial screws to achieve an implant construct as necessary for the individual case. The system also includes the instruments necessary for inserting and securing the implants. The implant system is intended to be removed after solid fusion has occurred.

The Virage System implants are fabricated from medical grade titanium alloy and medical grade cobalt chromium alloy. Implants made from medical grade titanium, medical grade titanium alloy, and medical grade cobalt chromium may be used together. Never use titanium, titanium alloy, and/or cobalt chromium with stainless steel in the same construct. All implants are single use only and should not be reused under any circumstances.

The titanium Lentur™ Cable System used with the Virage OCT Spinal Fixation System to allow for cable attachment to the posterior cervical or thoracic spine is optional and not approved in all countries.

Materials

Implants: The Virage System implants are fabricated from medical grade titanium alloy per ASTM F136 and medical grade cobalt chromium alloy per ASTM F1537.

Instruments: The Virage System instrumentation is generally made from stainless steel, aluminum, titanium, and polymeric materials.

Indications for Use

The Virage OCT Spinal Fixation System is intended to provide immobilization and stabilization of spinal segments as an adjunct to fusion for the following acute and chronic instabilities of the craniocervical junction, the cervical spine (C1–C7) and the thoracic spine from T1–T3; traumatic spinal fractures and/or traumatic dislocations; instability of deformity; failed previous fusions (e.g., pseudoarthrosis); tumors involving the cervical spine; and degenerative disease, including intractable radiculopathy and/or myelopathy, neck and/or arm pain of discogenic origin as confirmed by radiographic studies, and degenerative disease of the facets with instability. The Virage OCT Spinal Fixation System is also intended to restore the integrity of the spinal column even in the absence of fusion for a limited time period in patients with advance stage tumors involving the cervical spine in whom life expectancy is of insufficient duration to permit achievement of fusion.

In order to achieve additional levels of fixation, The Virage OCT Spinal Fixation System may be connected to the Instinct Java and Sequoia Spinal Systems offered by Zimmer Spine, using rod connectors and transition rods. Refer to the Instinct Java and Sequoia Spinal System package insert for a list of the system specific indications of use.

The titanium Lentur™ Cable System to be used with the Virage OCT Spinal Fixation System allows for cable attachment to the posterior cervical or thoracic spine.

Contraindications

The Virage System is not designed or sold for any use except as indicated. **DO NOT USE THE VIRAGE SYSTEM IMPLANTS IN THE PRESENCE OF ANY CONTRAINDICATION.**

Contraindications include, but are not limited to:

- Overt infection or distant foci of infections.
- Local inflammation, with or without fever or leukocytosis.
- Pregnancy.
- Morbid obesity.
- Rapid joint disease, bone absorption, osteopenia, and/or osteoporosis.
- Suspected or documented metal allergy or intolerance.
- Any time implant utilization would interfere with anatomical structures or expedited physiological performance, such as impinging on vital structures.
- Severe comminuted fractures such that segments may not be maintained in satisfactory proximate reduction.
- Use in displaced, non-reduced fractures with bone loss.
- The presence of marked bone absorption or severe metabolic bone disease that could compromise the fixation achieved.
- Poor prognosis for good wound healing (e.g., decubitus ulcer, end-stage diabetes, severe protein deficiency, and/or malnutrition).
- Any case not needing a bone graft or fusion.
- Any case not described in the indications.

See the Warnings and Precautions section.

Warnings

Following are specific warnings, precautions, and adverse effects associated with use of the Virage System that should be understood by the surgeon and explained to the patients. General surgical risk should be explained to the patients prior to surgery.

- Implantation of the Virage System should be performed only by experienced spinal surgeons.
- All implants are intended for single use only. Single-use devices should not be re-used. Possible risks associated with re-use of single-use devices include:
 - Mechanical malfunction
 - Transmission of infectious agents
- Metal sensitivity has been reported following exposure to orthopedic implants. The most common metallic sensitivities (nickel, cobalt, and chromium) are present in medical grade stainless steel and cobalt-chrome alloys.
- The Virage System is a temporary internal fixation device. Internal fixation devices are designed to stabilize the operative site during the normal healing process. After healing occurs, these devices serve no functional purpose and should be removed. Implant removal should be followed by adequate postoperative management to avoid fracture or refracture.

- Universal precautions should be observed by all end users that work with contaminated or potentially contaminated medical devices. Caution should be exercised when handling devices with sharp points or cutting edges to prevent injuries during and after surgical procedures and reprocessing.
- **Warning:** The safety and effectiveness of pedicle screw spinal systems have been established only for spinal conditions with significant mechanical instability or deformity requiring fusion with instrumentation. These conditions are significant mechanical instability or deformity of the thoracic, lumbar, and sacral spine secondary to severe spondylolisthesis (grades 3 and 4) of the L5–S1 vertebra, degenerative spondylolisthesis with objective evidence of neurological impairment, fracture, dislocation, scoliosis, kyphosis, spinal tumor, and failed previous fusion (pseudoarthrosis). The safety and effectiveness of these devices for any other conditions are unknown.
- **Precaution:** The implantation of spinal fixation systems should be performed only by experienced spinal surgeons with specific training in the use of these spinal systems because this is a technically demanding procedure presenting a risk of serious injury to the patient. Preoperative planning and patient anatomy should be considered when selecting implant diameter and length.

Additional preoperative, intraoperative, and postoperative warnings and precautions:

Preoperative

- **Pre-op Planning:** Use of cross sectional imaging (i.e., CT and/or MRI) for posterior cervical screw placement is recommended due to the unique risks in the cervical spine. The use of planar radiographs alone may not provide the necessary imaging to mitigate the risk of improper screw placement. In addition, use of intraoperative imaging should be considered to guide and/or verify device placement, as necessary.
- Usage of automated cleaning processes without supplemental manual cleaning may not result in adequate cleaning of instruments.
- Proper handling, decontamination (including pre-rinsing, washing, rinsing and sterilization), storage and utilization are important for the long and useful life of all surgical instruments. Even with correct use, care and maintenance, they should not be expected to last indefinitely. This is especially true for cutting instruments (e.g., bone awls/drills) and driving instruments (e.g., drivers). These items are often subjected to high loads and/or impact forces. Under such conditions, breakage can occur, particularly when the item is corroded, damaged, nicked or scratched.
- Never use titanium, titanium alloy, and/or cobalt chromium with stainless steel in the same implant construct; otherwise, galvanic corrosion may occur. See DESCRIPTION section for Virage System materials and compatibility information.

Intraoperative

- If contouring of the implant is necessary for optimal fit, the contouring should be gradual and avoid any notching or scratching of the implant surface. Do not repeatedly or excessively bend the implant. Do not reverse bend the plate or rods.
- Bending the plate outside of the bend zone groove may result in cracking of the plate. Surgeon should always inspect the plate before implanting.
- Occiput and pedicle bone integrity should be verified.
- Care should be taken during occiput and pedicle preparation to avoid penetrating too deep.
- Care should be taken to ensure occipital screw is not driven in too deep.
- Care should be taken during bone preparation to avoid damage to the pedicle and to the surgical instruments.
- Care should be taken to minimize soft tissue damage during surgery.
- Care should be taken to avoid removing excess material from the Lamina.
- Care should be taken to avoid cross-threading screws and closure tops.
- If any implant or instrument comes in contact with a non-sterile surface it should not be used.

Postoperative

- Adequately instruct the patient. Postoperative care and the patient's ability and willingness to follow instructions are some of the most important aspects of successful bone healing. The patient must be made aware of the limitations of the implant and that physical activity and full weight bearing have been implicated in fracture. The patient should understand that an implant is not as strong as normal, healthy bone and will fracture if excessive demands are placed on it in the absence of complete bone healing. An active, debilitated, or demented patient who cannot properly use weight-supporting devices may be particularly at risk during postoperative rehabilitation.
- The Virage System is a temporary internal fixation device. Internal fixation devices are designed to stabilize the operative site during the normal healing process. After healing occurs, these devices serve no functional purpose and should be removed. Implant removal should be followed by adequate postoperative management to avoid fracture or refracture.

Disclaimer: This documentation is intended exclusively for physicians and is not intended for laypersons. Information on the products and procedures contained in this document is of a general nature and does not represent and does not constitute medical advice or recommendations. Because this information does not purport to constitute any diagnostic or therapeutic statement with regard to any individual medical case, each patient must be examined and advised individually, and this document does not replace the need for such examination and/or advice in whole or in part.



Caution: Federal (USA) law restricts this device to sale by or on the order of a physician. Rx Only. Please refer to the package inserts for important product information, including, but not limited to, indications, contraindications, warnings, precautions, adverse effects, and patient counseling information.



Manufactured by:
Zimmer Biomet Spine, Inc
10225 Westmoor Dr.
Westminster, CO 80021 USA
+1 800.447.3625



Zimmer GmbH
Sulzerallee 8
CH-8404 Winterthur
Switzerland
+41 058.854.80.00



ZIMMER BIOMET
Your progress. Our promise.®

zimmerbiomet.com

©2018 Zimmer Biomet Spine, Inc. All rights reserved.

All content herein is protected by copyright, trademarks and other intellectual property rights owned by or licensed to Zimmer Biomet Spine, Inc. or one of its affiliates unless otherwise indicated, and must not be redistributed, duplicated or disclosed, in whole or in part, without the express written consent of Zimmer Biomet Spine. This material is intended for health care professionals, the Zimmer Biomet Spine sales force and authorized representatives. Distribution to any other recipient is prohibited.

0270.3-GLBL-en-REV1018